

Hydraulic valves and hydro- electric pressure switches

for industrial applications

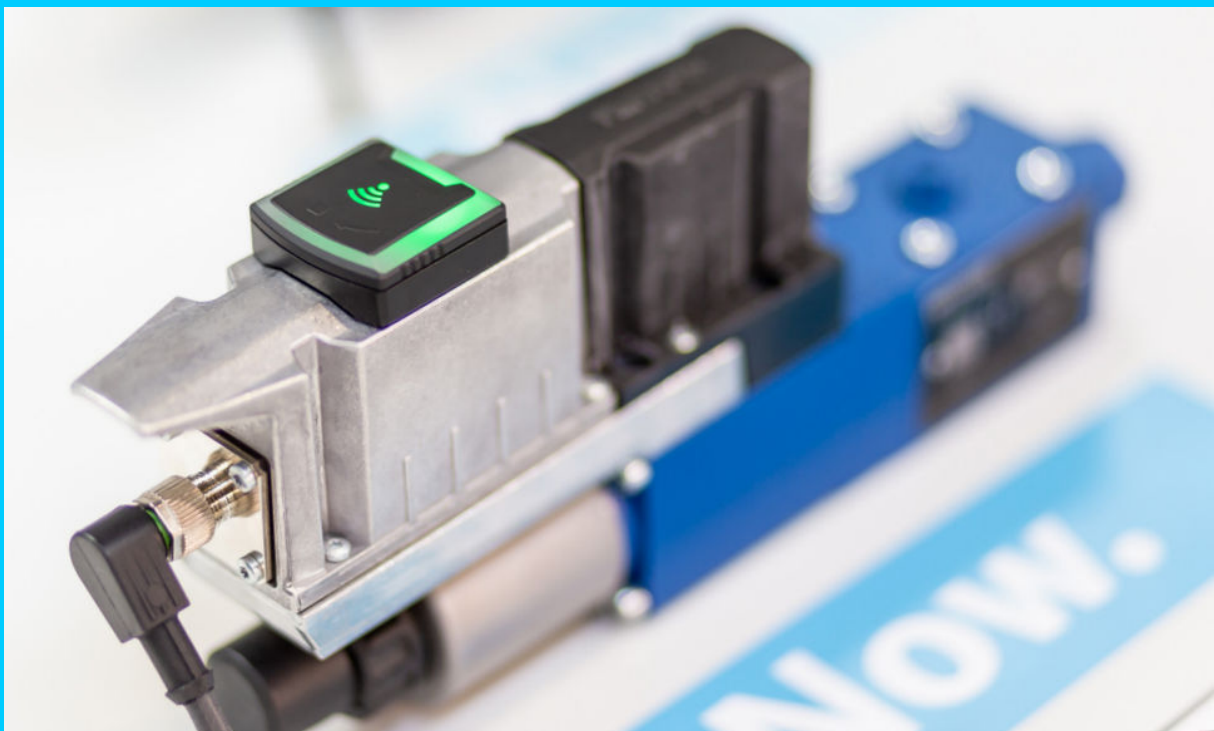

Copyright

© Bosch Rexroth AG © 2024

All rights reserved, also regarding any disposal, exploitation, reproduction, editing, distribution, as well as in the event of applications for industrial property rights.

Liability

The specified data is intended for product description purposes only and shall not be deemed to be a guaranteed characteristic unless expressly stipulated in the contract. All rights are reserved with respect to the content of this documentation and the availability of the product.

English

Table of contents

1	About this documentation	5
1.1	Validity of the documentation	5
1.2	Required and amending documentation	5
1.3	Representation of information	5
1.3.1	Safety instructions	5
1.3.2	Symbols	6
1.3.3	Abbreviations	6
2	Safety instructions	7
2.1	About this chapter	7
2.2	Intended use	7
2.3	Improper use	7
2.4	Qualification of personnel	8
2.5	General safety instructions	8
2.6	Product-specific safety instructions	9
2.7	Obligations of the machine end-user	12
3	General information on damage to property and damage to the product	13
4	Scope of delivery	15
5	About this product	17
6	Transport and storage	19
6.1	Transporting the hydraulic valve	19
6.2	Storage of hydraulic components	20
7	Assembly and installation	23
7.1	Unpacking	23
7.2	Painting the hydraulic valve	23
7.3	Installation conditions	23
7.4	Before the assembly	24
7.5	Required tools	24
7.6	Assembling the hydraulic valve or pressure switch	25
7.7	Hydraulically connecting the hydraulic valve	26
7.8	Connecting the power supply (only for hydraulic valves with solenoid control or on-board electronics and hydro- electric pressure switches)	27
8	Commissioning	29
8.1	Bleeding the hydraulic system	30
8.2	Operating the manual override	30
9	Operation	33
10	Maintenance and repair	35
10.1	Cleaning and care	35
10.2	Inspection and maintenance	35
10.3	Repair	35
10.4	Spare parts	36
11	Disassembly and replacement	37
12	Disposal	39
12.1	Environmental protection	39
12.2	Return to Bosch Rexroth AG	39
12.3	Packaging	39

12.4	Materials used	39
12.5	Recycling	39
13	Extension and modification	41
13.1	Optional accessories	41
14	Troubleshooting	43
14.1	How to proceed for troubleshooting	43
14.1.1	Fault table for hydraulic valves and pressure switches	43
15	Technical data	45
16	List of addresses	47
17	Index	49

1 About this documentation

1.1 Validity of the documentation

This documentation applies to the following hydraulic components for industrial applications:

Hydraulic valves:

- On/off valves
 - Isolator, directional, pressure and flow control valves
- Proportional servo valves:
 - Directional, pressure and flow control valves

Pressure switches:

- Hydro-electric pressure switches

This documentation is intended for machine manufacturers, assemblers and system end-users.

This documentation contains important information on the safe and proper transport, assembly, commissioning, operation, use, maintenance, simple troubleshooting, disassembly and disposal of a hydraulic valve and/or a hydro-electric pressure switch.



Read this documentation and, in particular, [↔ Chapter 2 Safety instructions on page 7](#) completely before working with the product.

1.2 Required and amending documentation

In addition to these operating instructions, you should always read the relevant product data sheet. The data sheets are available on the Internet at [↔ www.boschrexroth.com/mediadirectory](http://www.boschrexroth.com/mediadirectory). Under "Search", you can enter the valve or pressure switch designation or the five-digit data sheet number.



- Only commission the product once you have been provided with the documentation marked with the book symbol  and you have understood and observed it.

Table 1: Required and amending documentation

	Title	Document no.	Document type
	Order confirmation		
	Data sheet of the relevant valve or pressure switch		Data sheet
	Operating instructions of the relevant valve or pressure switch		Operating instructions



Documentation on the overall circuit diagram of the machine is available from the machine manufacturer.

1.3 Representation of information

Consistent safety instructions, symbols, terms and abbreviations are used in this documentation so that you can quickly and safely work with your hydraulic product. For a better understanding, they are explained in the following sections.

1.3.1 Safety instructions

In this documentation, safety instructions are contained in chapter [↔ Chapter 2 Safety instructions on page 7](#) and in chapter [↔ Chapter 3 General information on damage to property and damage to the product on page 13](#) and before

sequences of actions or instructions where there is a danger of personal injury or damage to property. The measures described for hazard avoidance must be observed.

Safety instructions are structured as follows:

▲ WARNING	Type and source of danger! or consequences of non-compliance <ul style="list-style-type: none"> – Hazard avoidance measures – Enumeration
------------------	--

- **Warning sign:** draws attention to the danger
- **Signal word:** identifies the degree of danger
- **Type and source of danger:** Specifies the type and source of danger
- **Consequences:** describes the consequences of non-compliance
- **Precautions:** specifies how the danger can be prevented

Risk classes according to ANSI Z535.6-2011

▲ DANGER	In the case of non-compliance with these safety instructions, death or severe injury will occur .
▲ WARNING	In the case of non-compliance with these safety instructions, death or severe injury may occur .
▲ CAUTION	In the case of non-compliance with these safety instructions, minor or moderate (personal) injury may occur .
NOTICE	In the case of non-compliance with these safety instructions, damage to property may occur .

1.3.2 Symbols

The following symbols indicate notes which are not safety-relevant but increase the comprehensibility of the documentation.



If this information is not observed, the product cannot be optimally used and/or operated.

- Individual, independent action
- Numbered instruction: The numbers indicate that the actions must be carried out one after the other.

1.3.3 Abbreviations

The following abbreviations are used in this documentation:

Table 2: Abbreviations

Designation	Meaning
ANSI	American National Standards Institute
PE	Protective Earth
PELV	Protective extra-low voltage

2 Safety instructions

2.1 About this chapter

Bosch Rexroth hydraulic valves and hydro-electric pressure switches are manufactured according to the generally accepted code of practice. However, there is still the danger of personal injury and damage to property if you do not observe this chapter and the safety instructions in this documentation.

- Read this documentation completely and thoroughly before working with the product.
- Keep this documentation in a location where it is accessible to all users at all times.
- Always include the required documentation when passing the product on to third parties.

2.2 Intended use

The product is a hydraulic component. It is intended for use in industrial systems and machines. You may use the hydraulic valve and/or the hydro-electric pressure switch as follows:

- In compliance with the application and environmental conditions according to the data sheet.
- In compliance with the specified performance limits.
- Use in the original condition, without damage.
- Repairs by customers are not admissible. Maintenance with approved spare parts only. Have defective products exchanged right away and replace them with a new device or original spare parts.

The hydraulic valve and/or the hydro-electric pressure switch is exclusively intended for professional use and not for private use. Intended use includes having read and understood this documentation completely, especially this chapter 2 "Safety instructions".

2.3 Improper use

Any use deviating from the intended use is improper and thus not admissible.

Any use as a safety component is not admissible unless explicitly specified in the data sheet or other operating instructions.

Improper use of the hydraulic valve includes:

- Use in potentially explosive environments
- Incorrect storage
- Incorrect transport
- Lack of cleanliness during storage and assembly
- Incorrect installation
- Use of inappropriate/non-admissible media
- Exceedance of the specified maximum pressures
- Operation outside the approved temperature range

Bosch Rexroth AG does not assume any liability for damage caused by improper use. The user assumes responsibility for all risks surrounding improper use.

2.4 Qualification of personnel

Handling the products requires basic knowledge of mechanics, hydraulics and electrics as well as knowledge of the appropriate technical terms. In order to ensure safe use, these activities may only be carried out by an expert in the respective field or an instructed person under the direction and supervision of an expert.

Experts are those who can recognize potential dangers and apply the appropriate safety measures due to their professional training, knowledge and experience, as well as their understanding of the relevant conditions pertaining to the work to be undertaken. An expert must observe the relevant specific professional rules and have the necessary expert knowledge. Expert knowledge means for example for hydraulic products:

- Reading and completely understanding hydraulic schemes,
- in particular, completely understanding the relationships regarding the safety equipment, and
- having knowledge of the function and set-up of hydraulic components.



Bosch Rexroth offers measures supporting training in specific fields. An overview over the training contents can be found online at: [↔ https://www.boschrexroth.com](https://www.boschrexroth.com)

2.5 General safety instructions

- Observe the valid regulations on accident prevention and environmental protection.
- Observe the safety regulations and provisions of the country where the hydraulic valve and/or the pressure switch is implemented/used.
- Only use Rexroth products in technically perfect condition.
- Observe all information on the product.
- Persons who assemble, operate, disassemble or maintain Rexroth hydraulic valves or pressure switches must not consume any alcohol, drugs or pharmaceuticals that may affect their ability to react.
- Only use original Rexroth accessories and spare parts in order to exclude any hazard to persons due to unsuitable spare parts.
- Comply with the technical data and environmental conditions specified in the product documentation.
- The installation or use of inappropriate products in safety-relevant applications could result in unintended operating conditions when being used, which in turn could cause personal injuries and/or damage to property. Therefore, only use a product for safety-relevant applications if this use is expressly specified and permitted in the documentation of the product, or if the safe suitability of the product in the application is confirmed by a separate conformity assessment procedure, for example, in explosion-protected areas or in safety-related parts of control systems (functional safety).
- Do not commission the product until you can be sure that the end product (for example, a machine or system) in which the Rexroth product is installed complies with the country-specific provisions, safety regulations, and standards of application.

2.6 Product-specific safety instructions

▲ WARNING

Pressurized system parts and leaking hydraulic fluid!

When working on hydraulic systems with stored energy (accumulators or cylinders working under gravity), hydraulic valves can remain under pressure even after the pressure supply has been switched off. During assembly and disassembly works, hydraulic valves, pressure switches or parts may fly around and cause personal injuries and/or damage to property. There is also the danger of serious injury caused by a powerful jet of hydraulic fluid escaping.

- Ensure before working at the hydraulic product that the hydraulic system is depressurized and the electrical control de-energized.
- Before working on hydraulic products, completely relieve the pressure on machines and systems.

▲ WARNING

Non-compliance with functional safety!

Hydraulic valves control movements in machines or systems. In the case of mechanical and electric faults, e.g. failure of the energy supply, persons may be caught, thrown or crushed by the system.

- When setting up your circuit, observe functional safety e.g. according to EN ISO 13849.

▲ WARNING

Easily inflammable hydraulic fluid!

In connection with fire or other hot heat sources, leaking hydraulic fluid mist due to defective or incompletely assembled hydraulic valves and pressure switches and their connections may lead to fire or explosions.

- Do not use hydraulic products in areas with open fire and only ensuring sufficient distance to hot heat sources.

▲ WARNING

Faulty mounting!

Mounting of the hydraulic valves with mounting screws of reduced stability, insufficient mounting or fastening at blocks and plates with insufficient stability may lead to the hydraulic valve becoming loose and falling down. Consequently, hydraulic fluid may leak and lead to personal injuries and/or damage to property. Hydraulic valves with high weight may bruise or kill persons. Special care must be taken with hydraulic valves with suspended installation.

- Assemble hydraulic valves completely according to the assembly instructions using suitable assembly aids.
- Mount the hydraulic valves only on blocks or plates suitable for the weight of the valves.
- Comply with tightening torques and screw stabilities.

Only for valves with electric control

▲ WARNING

High electrical voltage!

With hydraulic valves with supply voltage >50 VAC or 75 VDC, touching an electric part on the product may lead to a fatal electric shock.

- The hydraulic valve must be connected only by a specialized electrician or under supervision of the same.
- Switch off the voltage supply before all maintenance, repair or installation works and secure it against restarting.
- Provide for proper, safe PE connection.
- Only use power supply units with safe voltage separation PELV (Protective Extra-Low Voltage). Safe isolation can be achieved with isolation transformers, safe optocouplers or mains-free battery operation.

▲ WARNING

Electro-magnetic radiation!

Hydraulic valves with electronic parts may impair other electronics and unshielded connection lines by emitting electro-magnetic radiation and can themselves be impaired, which can result in uncontrolled motions within the system.

- Observe the limit values for electro-magnetic radiation.
- Only use recommended electric connection lines.
- Ensure EMC-compliant wiring.
- Provide for proper grounding of the valves.
- If required, shield other electronics and the valve electronics.
- Ensure sufficient distance between the valve electronics and sources of interference.

▲ WARNING

Missing equipotential bonding!

Electrostatic processes, an incorrect grounding concept or missing equipotential bonding may lead to malfunctions or uncontrolled movements at the machine and thus cause injuries.

- Provide for correct grounding and proper equipotential bonding.

▲ WARNING

Penetrating water and humidity!

In case of use in humid or wet environments, water or humidity may penetrate at electrical plug-in connectors or the valve electronics. This case may lead to malfunctions at the valve and to unexpected movements in the hydraulic system which may result in personal injury and damage to property.

- Only use the hydraulic valve within the intended IP protection class or lower.
- Ensure before the assembly that all seals and caps of the plug-in connections are tight and intact.

▲ CAUTION

Contaminated hydraulic fluid!

Contamination in the hydraulic fluid may cause functional failures e.g. jamming or blocking of nozzles of the hydraulic valve. In the worst case, this may result in unexpected system movements and thus constitute a risk of injury for persons.

- Ensure adequate hydraulic fluid cleanliness according to the cleanliness classes of the hydraulic valve over the entire operating range.

▲ CAUTION

Hot surfaces!

Hydraulic valves and valve solenoids may reach high temperatures during operation. Skin contact can cause burns, and contact with materials that are flammable or not heat-resistant can lead to damage to property or fire hazard.

- Avoid contact with hydraulic valves and their solenoids during operation.
- Allow hydraulic valves to cool down before touching them or wear protective gloves.
- Keep materials that are flammable or not heat-resistant away from hydraulic valves.
- Remove dust and dirt accumulations on the hydraulic device at regular intervals.
- If necessary, attach protective covers.

▲ CAUTION

Exceeding of maximum temperatures!

Use of the hydraulic valves outside the temperature intended for that purpose may lead to functional failures such as overheating of the valve solenoids. In the worst case, this may result in unexpected system movements and thus constitute a risk of injury for persons.

- Only use the hydraulic valves within the environmental and fluid temperatures intended for that purpose.

▲ CAUTION

Leakage in case of incorrect working temperatures!

Use of the hydraulic valves outside the temperature intended for that purpose may lead to permanent leakage at the hydraulic valves. Thus, hydraulic fluid in the form of a leaking hydraulic fluid jet may injure persons, lead to damage to property and endanger the environment.

- Only use the hydraulic valves within the environmental and fluid temperatures intended for that purpose.
- In case of leakage, immediately exchange damaged seal rings or the hydraulic valve.

⚠ CAUTION**Corrosion!**

If the hydraulic valve is used in humid environments or water, the hydraulic valves and mounting screws may corrode. Thus, the mounting screws and the hydraulic valves lose their stability and may become loose and thus constitute a risk of injury.

- Use mounting screws with adequate corrosion protection and exchange the mounting screws with serious corrosion damage.
- Provide for adequate corrosion protection and exchange valves with serious corrosion damage at an early stage.



Contact with salt water leads to increased corrosion at the hydraulic valve. Mounting screws and plug screws as well as moveable components such as hand levers may be chemically corroded and damaged. Take suitable corrosion protection measures.

2.7 Obligations of the machine end-user

The operation of installations, systems and machines fundamentally requires the implementation of a holistic IT security concept which is state-of-the-art in terms of technology. Accordingly, Bosch Rexroth products and their properties have to be considered as components of installations, systems and machines for their holistic IT security concept. Unless otherwise documented, Bosch Rexroth products are designed for operation in local, physically and logically secured networks with access restrictions for authorized persons, and they are not classified according to IEC 62443-4-2.

3 General information on damage to property and damage to the product

The warranty only applies to the delivered configuration. The claim to warranty expires if the product is assembled, commissioned and operated incorrectly, not used as intended and/or handled improperly.

NOTICE

Inadmissible mechanical load!

Impact or shock forces on hydraulic valves or pressure switches may damage or even destroy them.

- Never use hydraulic components as a handle or step. Do not place/position any objects on top of them.

NOTICE

Dirt and foreign particles in hydraulic components!

Penetrating dirt and foreign particles lead to wear and malfunctions. Safe function of the hydraulic components is no longer ensured.

- During assembly, ensure utmost cleanliness in order to prevent foreign particles such as welding beads or metal chips from getting into the hydraulic lines.
- Do not use linting fabric for cleaning.
- Ensure that no cleaning agents are able to enter the hydraulic system.

NOTICE

Hydraulic fluid harmful to the environment!

Leaking hydraulic fluid leads to environmental pollution.

- Immediately remedy possible leakage.
- Dispose of the hydraulic fluid in accordance with the currently applicable national regulations in your country.

Only for electric components

NOTICE

Uncontrolled disconnection and connection of plug-in connectors!

Product might be destroyed!

- Before installation works, separate the product from the mains or from the voltage source or de-energize it.
- Do not plug in or pull off the electric plug-in connector as long as the voltage supply is activated.

4 Scope of delivery



For information on the scope of delivery please refer to the delivery documents and/or the data sheet of your hydraulic valve and/or pressure switch.

- Check the scope of delivery for completeness.
- Check the scope of delivery for possible transport damage, see [↔ Chapter 6 Transport and storage on page 19](#).



In case of complaints, please contact Bosch Rexroth AG, see [↔ Chapter 16 List of addresses on page 47](#).

5 About this product



For information on the performance and product description, please refer to the data sheet of your hydraulic valve or pressure switch. For the data sheet see → www.boschrexroth.com

6 Transport and storage

For transport and storage of the product always observe the environmental conditions specified in the technical data (see data sheet).

6.1 Transporting the hydraulic valve

Bosch Rexroth hydraulic valves are high-quality products. In order to prevent damage to the hydraulic valve or pressure switch, transport the products in their original packaging or with equivalent transportation protection.

▲ WARNING

Unsecured hydraulic valves toppling over or falling down!

Unsecured hydraulic valves may topple over or fall down and bruise or kill persons if they are heavy.

- Use the original packaging for transport.
- Provide for a stable position during transport to the place of installation.
- Until complete assembly, transport and secure the hydraulic valve at the intended lifting eyes and not at parts with little stability, e.g. solenoids, connectors and cables.
- Use only suitable lifting gear for transport.
- Wear your personal protective equipment.
- Comply with the national laws and regulations regarding occupational health and safety and transport.

▲ CAUTION

Heavy components!

When lifting a hydraulic valve with high weight, there is a danger of damage to health.

- Transport the hydraulic valves at the lifting eyes provided for that purpose.
- Use a suitable lifting, putting down and moving technique. Observe the weight of the hydraulic valve, the center of gravity and the intended mounting and attachment points when transporting the valve.
- During transport, secure the hydraulic valves against toppling over.
- Products > 15 kg are usually provided with lifting eyes. Use these lifting eyes.
- Do not jam the hydraulic valve.
- Put the hydraulic valve carefully onto the contact surface in order not to damage it.

When using lifting gear during transport, also consider the following points:

- Ensure that the lifting gear's lifting capacity is sufficient in order to ensure risk-free transport of the hydraulic valve.
- Use admissible textile attachment devices – e.g. according to DIN EN 1492-2.
- Fasten the transport belt at the provided eyebolts
OR
Position a transport belt around the hydraulic valve so that it does not run over the attachment parts (e.g. pilot control valve, solenoids), see figure below.
- Never step or reach below suspended loads.

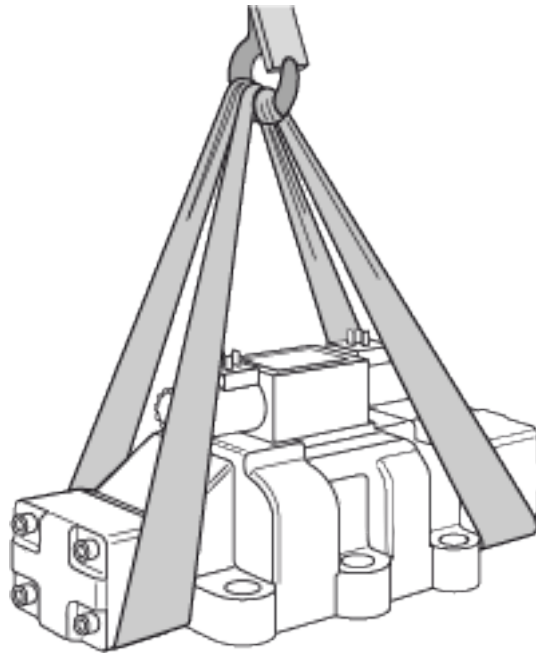

Fig. 1: Position of the transport belt

6.2 Storage of hydraulic components



Rexroth hydraulic components are delivered in perfect condition. Improper storage may damage the hydraulic product.

Hydraulic valves and pressure switches are suitable for storage for up to 12 months under the following conditions:

- Do not store the hydraulic component outdoors but in a well-ventilated room.
- Store the products between +5 °C and +40 °C.
- For the purpose of short-time transportation, the ambient temperature range according to the data sheet shall apply.
- Protect the hydraulic component against humidity, particularly ground humidity. Store the hydraulic component in the shelf or on a pallet. The relative air humidity must not exceed 65% and there must not be any condensation.
- Provide for 100% UV protection.
- Ensure that no ozone formation takes place near the storage location.
- Store the hydraulic component in packaging in order to protect it from dust and dirt.
- All connections at the hydraulic valve must be closed with cap elements.
- After opening the transport packaging, it must be closed properly again for storage.
- Use the original packaging for storage.
- Remove the covers at the hydraulic connections of the hydraulic valve only before the assembly.

If the storage period exceeds one year or if sea transport is necessary, please contact Bosch Rexroth.

7 Assembly and installation

7.1 Unpacking

Dispose of the packaging in accordance with the currently applicable national provisions in your country.

7.2 Painting the hydraulic valve

NOTICE**Paint on the valve solenoids!**

Painting of the valve solenoids causes excessive heating during operation and may thus destroy the hydraulic valve and in the worst case lead to an unexpected system movement.

- Valve solenoids and electronic part must not be painted. Protect the valve solenoid surface against paint application.

- Protect the mounting bores, the name plate and the existing information signs against paint application.
- Mask available connectors of the electrical connections with protective foil and make sure not to cause any damage to the connector.



After painting, the name plate must be readable.

7.3 Installation conditions

- For installing the product always observe the environmental conditions specified in the data sheet.
- It is imperative to provide for absolute cleanliness. The hydraulic component must be installed free of dirt. Contamination of the hydraulic fluid may considerably impair the life cycle of the hydraulic component.
- Observe the installation position specified in the data sheet.

7.4 Before the assembly

▲ WARNING**Use of an incorrect product!**

An incorrect product causes a malfunction in the system. This can lead to unexpected movement in the machine, resulting in personal injury and damage to property!

- Prior to installation of the hydraulic component, check that the material number and type designation on the name plate match your parts list or order number.

▲ WARNING**Exceeding the maximum operating pressure of the hydraulic component!**

If the maximum operating pressure is exceeded, the hydraulic component may burst, closure elements may be ejected or external leakage may occur. Danger of personal injury and damage to property!

- Observe the information on the maximum operating pressure on the product's name plate.
- Do not use the product if the specified maximum operating pressure does not match the required system pressure.

- Before installation of the hydraulic component, check compliance of the type designation on the name plate with your job or order number.
- Observe the information on the maximum operating pressure on the name plate.

7.5 Required tools

In order to assemble the hydraulic component, you need standard tools only.

7.6 Assembling the hydraulic valve or pressure switch

▲ WARNING

Faulty installation of plug screws and lines!

Improperly fastened plug screws and lines may become loose during subsequent operation and fly around due to the pressure and thus cause serious injury.

- Only pressurize your system after all plug screws and lines have been completely and properly mounted according to the specifications.

▲ CAUTION

Insufficient installation space!

Insufficient installation space may lead to jamming or abrasions in case of actuation and adjustment works at the hydraulic components.

- Provide for sufficient installation space.
- Ensure that actuation, adjustment elements and plug-in connectors are easily accessible.

▲ CAUTION

Leaking hydraulic fluid!

Hydraulic fluid may leak during assembly and disassembly of hydraulic components. Consequently, persons may slip or fall.

- Only remove the protective caps at hydraulic valves directly before the assembly.
- After the disassembly, provide the bores containing the hydraulic fluid with suitable cap elements.
- Immediately remove hydraulic fluid that has leaked out.

▲ CAUTION

Sharp edges!

Hydraulic valves, especially cartridge valves, may have sharp edges at the valve openings. There is a risk of cuts or abrasions during transportation or assembly/disassembly.

- Wear appropriate protective clothing during transport.
- Do not reach into valve openings!





Have sufficiently dimensioned collecting containers, non-linting cloth and medium-binding materials ready in order to collect or bind leaking medium.

Assembly steps for hydraulic valves and pressure switches on subplates

The connection surfaces of the hydraulic component and the subplate must be clean and free of hydraulic fluid.

- Use non-linting fabric for cleaning the subplate.
1. Remove the protective cover at the hydraulic component.
 2. Ensure correct orientation of the hydraulic component. With hydraulic valves, observe the porting pattern according to the symbol and connection labeling at the valve.
 3. Check whether all seal rings are available and intact.
 4. Carefully put the hydraulic component onto the connection surface.
 5. Use mounting screws according to the dimensions and the property class specified in the data sheet.

6.  Ensure that the mounting screws are tightened using the specified tightening torque. For the tightening torques, please refer to the corresponding data sheets.
7.  Please note that the tightening torques may change if other screw types are used.
8.  If hydraulic valves are fastened using more than 4 mounting screws, tighten the screws in the middle first.

Further information on electrical connections is contained in the corresponding data sheet.



Assembly of hydraulic valves with threaded connection at the block or the power unit

▲ WARNING



Insufficiently fastened threaded connection valves!

During operation, insufficiently fastened threaded connection valves may start to oscillate, become loose and cause serious injury.





- Do not fasten threaded connection valves at the pipe fitting or at the hydraulic hoses.
- Screw the hydraulic valves to the intended screwing points applying the specified tightening torques.

1.  Completely assemble the threaded connection valves first.
2.  Then connect the threaded connections with pipes or hydraulic hoses according to the information in the data sheet.

Assembly of cartridge valves

1.  Check whether all seal rings are present and intact.
2.  Ensure during insertion of the cartridge valves that the hydraulic valves are not jammed.
3.  Completely insert the cartridge valves into the installation bore and then assemble the cover plate applying the tightening torque specified in the data sheet.

7.7 Hydraulically connecting the hydraulic valve

1.  Depressurize the relevant system part.
2.  Establish all connections observing the operating instructions of the system.
3.  Make sure that pipes and/or hoses are connected to all ports and/or that the ports are closed with plug screws.
4.  Carry out a special check to make sure that the cap nuts and flanges are correctly tightened at the pipe fittings and flanges.
5.  Make sure that all pipes and hose lines and every combination of connection pieces, couplings or connection points with hoses or pipes are checked for their operational safety by a person with appropriate knowledge and experience.

7.8 Connecting the power supply (only for hydraulic valves with solenoid control or on-board electronics and hydro-electric pressure switches)

⚠ WARNING

High electrical voltage!

Danger to life, risk of injury caused by electric shock due to incorrect connection and faulty connection wiring.

- The hydraulic component must only be connected by a specialized electrician or under supervision of the same.
- De-energize the system before the assembly, pulling and connecting plug-in connectors and all other installation works. Secure the electrical equipment against restarting.
- Provide for proper, safe PE connection.
- Before switching on, check whether the protective grounding conductors at all electric devices are firmly connected according to the connection diagram.
- After connection, re-attach the cover so that it cannot be lost.

NOTICE

Uncontrolled disconnection and connection of plug-in connectors!

Product might be destroyed!

- Before installation works, separate the product from the mains or from the voltage source or de-energize it.
- Do not plug in or pull off the electric plug-in connector as long as the voltage supply is activated.

- The lines used have to be suitable for operating temperatures of -20 °C ... $+100\text{ °C}$.
- Make sure that the voltage supply is switched off.
- Connect the protective grounding conductor and the earthing correctly.
- Avoid sharply bending in the connection line and the braided wires in order to prevent short-circuits and interruptions.
- Only assemble the cable and line entry according to the assembly instructions.
- During the assembly, ensure leak-tightness between cable and cable and line entry.
- Route the connection line(s) in a strain-relieved form. The first mounting point must be within 15 cm of the cable entry.
- Use only lines satisfying the requirements on the terminal areas of the connection terminals according to the data sheet.



The protection class IP ... results from the mating connector that is used, see data sheet 08006.

The data sheet for the mating connectors is found on the Internet at www.boschrexroth.com/Rexroth-IHD



The solenoid coil is suitable for polarity-independent connection.

Only the mating connectors specified in the data sheet or mating connectors of the same type may be used.

Observe the assembly instructions printed on the packaging of the mating connector and the tightening torques specified in the same.

The sealing elements of the line entry are intended only for single use.

Due to the inductive effect, abruptly switching off the valve solenoid results in a voltage peak. However, additional external switching measures have to be taken to avoid connected electric circuits being influenced by the remaining residual voltage peak, if required.



After the assembly, attach a permanently readable information sign with the following labeling in the immediate vicinity of the valve solenoid: Do not separate when energized!

As protection against the hot solenoid surfaces, Bosch Rexroth recommends the installation of a touch guard so that unwanted contact with the hot surface can be avoided.

8 Commissioning

▲ WARNING

Faulty assembly, leaking hydraulic fluid!

Carelessly or faultily fastened hydraulic valves may become loose during operation and fall down and cause serious injury. A powerful fluid jet may leak at incompletely mounted hydraulic connections and connection lines and cause serious injury.

- Only commission your system after all hydraulic connections and the hydraulic valve have been completely and properly mounted according to the specifications.
- Look out for defective sealing points and exchange defective seal rings immediately.
- Wear personal protective equipment during the initial commissioning.

▲ WARNING

Inadmissibly high operating pressure!

In hydraulic applications with different area ratios, the hydraulic pressure is increased and may – in the case of incorrect design – lead to exceedance of the maximum admissible operating pressure. Thus, hydraulic valves may burst or the cap elements may fly around and cause serious injuries.

- Ensure before the commissioning of the hydraulic system that the maximum admissible pressure of the hydraulic valve in the system is not exceeded by any means.
- Ensure that in your system, the maximum admissible operating pressure is secured by means of a pressure limitation element.

▲ WARNING

Excessive pressure!

Incorrectly set pressure relief valves or valves not unloaded to the tank may lead to exceedance of the maximum admissible operating pressure. Thus, the hydraulic valves may burst or the cap elements may fly around and cause personal injury and/or damage to property.

- Before commissioning the hydraulic system, ensure correct setting and safe unloading of these pressure relief valves.

- Make sure that all hydraulic connections are closed and all electrical connections are allocated.
- Electrical connections must be checked for proper condition by or under the guidance and supervision of a specialized electrician before the initial or any re-commissioning.
- Commission hydraulic components only if they are completely installed.
- Allow hydraulic valves with on-board electronics to acclimatize for some time prior to commissioning, as the electronics may be damaged by the generation of condensed water.
- Immediately depressurize the system if hydraulic fluid continues to leak despite proper assembly and continue with [Chapter 14 Troubleshooting on page 43](#).

Information on the operating medium

- See the data sheet for the approved operating media and limitations of operation for your hydraulic component.
- Bosch Rexroth offers the suitable seal designs for the hydraulic fluid used. This information is also contained in the data sheet.

8.1 Bleeding the hydraulic system

Bleeding of the hydraulic valve is usually not necessary. However, Bosch Rexroth recommends bleeding the entire hydraulic system; while doing so, the following points are to be observed:

- Before the actual operation, switch the hydraulic valve several times with reduced pressure (50% operating pressure). This will expel any remaining air from the hydraulic valve.
- Do not switch the hydraulic valve under operating pressure as long as the system has not been bled, as this may cause damage to the hydraulic valve and to the system.

8.2 Operating the manual override

Hydraulic valves with electric solenoid actuation are provided with one manual override per solenoid. Using this manual override, the switching function of the hydraulic valve can also be triggered if the solenoid is not electrically energized.

NOTICE	<p>Incorrect operation of the manual override!</p> <p>There is a danger of damage to the manual override as well as the sealing surfaces at the solenoid.</p> <ul style="list-style-type: none"> – Operate the manual override by hand or using the special tool provided for this purpose (with .W...N9...) (see Table 4 Special tool on page 41).
---------------	---

The manual override is only intended for short-time manual operation and must not be brought into a certain spool position for a longer period or permanently by means of mechanical devices. The manual override is located at the side of the solenoid coil facing away from the solenoid coil.



With hydraulic valves, the manual override is only useful if the pressure in the tank channel of the hydraulic valve does not exceed 50 bar. Above this pressure value, the actuating force to be applied is relatively large.

Operation of the manual override is only valid for the subsequently listed types according to the type designation or data sheet.

Table 3: Explanation of the manual overrides

Type	Description	Figure
N	Manual override with protective cap (rubber cap)	

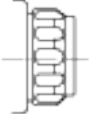
Type	Description	Figure
N9	Concealed manual override	 A technical drawing of a concealed manual override valve, showing a cross-section of the valve body with a central stem and a handle mechanism.

9 Operation



For information on operation, please refer to the operating instructions for the hydraulic system into which the hydraulic valve and/or the pressure switch is installed.

For safe operation, please observe the following warnings for hydraulic valves:

▲ CAUTION

Moving actuation elements!

The hand lever, the actuation roller or other actuation elements on mechanically actuated hydraulic valves perform movements during operation. This may lead to the jamming or bruising of parts of the body.

- When switching the hydraulic valves, pay attention to moving actuation elements.

▲ CAUTION

Loud noise!

If hydraulic valves are arranged incorrectly, resonance or fluid noises e.g. whistling may result. In continuous operation, these noises may cause hearing damage in persons or damage at the hydraulic valves.

- In this case, contact a service engineer.

In case of errors, refer to [Chapter 14 Troubleshooting on page 43](#).

10 Maintenance and repair

Rexroth hydraulic valves and pressure switches are usually maintenance-free. The seals of the hydraulic valves and pressure switches are subject to a natural process of wear and aging. We thus recommend replacing them at appropriate time intervals. The intervals are mainly determined by the operating conditions and the cleanliness of the hydraulic fluid.

- Regularly check the product and connection surfaces for leak-tightness!
- As a precaution, exchange seals at reasonable time intervals.



Preventive maintenance (e.g. hydraulic fluid care) as well as compliance with the pressure and temperature specifications extend the life cycle of the system and/or the hydraulic valve.

10.1 Cleaning and care

NOTICE

Solvents and aggressive cleaning agents!

Aggressive cleaning agents may damage the seals and the surface of the hydraulic components and cause the product to age faster.

- Do not use any solvents

NOTICE

Water jet!

A high-pressure washer's water pressure could damage the hydraulic system and the seals of hydraulic components.

- Do not use a high-pressure washer for cleaning.

- Close all openings with appropriate protective caps.
- Only clean hydraulic components using a damp, non-linting cloth. Only use water and a mild cleaning agent, if necessary, to do so.
- Remove dust and dirt accumulations on the hydraulic device at regular intervals.

10.2 Inspection and maintenance

NOTICE

Dirt and foreign particles in the hydraulic component!

Penetrating dirt and foreign particles in the hydraulic component lead to wear and malfunctions. Safe function of the hydraulic component is no longer ensured.

- During assembly, ensure utmost cleanliness in order to prevent foreign particles such as welding beads or metal chips from getting into the hydraulic lines.
- Do not use linting fabric for cleaning.
- Ensure that no cleaning agents are able to enter the hydraulic system.
- Flush the hydraulic system if necessary. Replace the fluid filter or the hydraulic fluid.

10.3 Repair

Bosch Rexroth offers a wide range of repair services for the hydraulic valve.

- Use only original spare parts from Bosch Rexroth to repair the Rexroth product.
- Partly tested and pre-assembled original Rexroth assemblies allow for successful repair works requiring only little time.

Remedying leakage at the mounting surface

- Remove the hydraulic component, see [↔ Chapter 11 Disassembly and replacement on page 37](#).
- Check recesses for seal rings on the mounting surface and clean the component contact surface with appropriate cleaning materials.
- Dry the component connection surface and the component contact surface using suitable cleaning materials.
- Install new seals.
- Re-assemble the hydraulic component on the contact surface, see [↔ Chapter 7 Assembly and installation on page 23](#).

10.4 Spare parts

The available spare parts and seal kits are specified in the relevant data sheets. The spare parts are available from the address specified in [↔ Chapter 16 List of addresses on page 47](#).

11 Disassembly and replacement

▲ WARNING

Pressurized and energized system parts!

When working on pressurized and energized system parts, there is the danger of injury by leaking hydraulic fluid or electric shock.

- Ensure that the hydraulic system is depressurized and the electrical control de-energized before disassembly.

▲ CAUTION

Incompletely mounted valve components falling down!

Incompletely disassembled valve components may fall down and cause injuries.

- During disassembly, secure the hydraulic valves against falling down.

▲ CAUTION

Abrupt release of elastic springs!

Hydraulic valves pre-loaded by elastic springs (e.g. 2/2 directional cartridge valve inserts) may be abruptly released during disassembly and cause injury due to parts flying around.

- For maintenance of hydraulic valves with pre-loaded springs, only open the covers slowly and using a disassembly tool if necessary.



Have sufficiently dimensioned collecting containers, non-linting cloth and medium-binding materials ready in order to collect or bind leaking hydraulic fluid.

1. De-energize and depressurize your system.
2. Unload the hydraulic accumulators, if applicable.
3. Switch off your system, disconnect the electrical voltage supply and protect the system against restarting before all disassembly work.
4. Provide for a clean environment during the disassembly.
5. Prepare a container or a pan for collecting the leaking hydraulic fluid.
6. Only loosen the mounting screws of the hydraulic component using a suitable tool.
7. Remove the mounting screws and lift the hydraulic component off the contact surface.
8. Collect escaping hydraulic fluid in the provided container and dispose of it properly.
9. If the product is to be returned to the manufacturer for repair, close the connection surface using the supplied protective plate or protect it using equivalent packaging in order to avoid contamination and damage.
10. Close the subplate in order to avoid contamination of your system.

In the case of new installation and/or exchange of the hydraulic component, perform the subsequent steps according to [Chapter 7.6 Assembling the hydraulic valve or pressure switch on page 25](#).

12 Disposal

12.1 Environmental protection

Careless disposal of the hydraulic components and the hydraulic fluid could lead to environmental pollution.

- Thus, dispose of the product and the hydraulic fluid in accordance with the currently applicable national regulations in your country.
- Dispose of any remaining hydraulic fluid in accordance with the applicable safety data sheets for this hydraulic fluid.
- Please observe the following information for the environmentally-friendly disposal of the hydraulic components.

12.2 Return to Bosch Rexroth AG

Hydraulic products manufactured by us can be returned to us for disposal free of charge. There must be no inappropriate foreign substances or third-party components when products are returned. Hydraulic valves have to be drained before being returned. The components have to be delivered free to the following address:

Bosch Rexroth AG
Industrial Hydraulics Service
Bürgermeister-Dr.-Nebel-Straße 8
97816 Lohr am Main
Germany

12.3 Packaging

Upon request, reusable systems can be used for regular deliveries.

The materials for disposable packaging are mostly cardboard, wood, and expanded polystyrene. They can be recycled without any problems. For ecological reasons, disposable packaging should not be used for returning products to Bosch Rexroth.

12.4 Materials used

Hydraulic components from Bosch Rexroth do not contain any hazardous materials that could be released during intended use. Normally, no negative effects on human beings and on the environment have to be expected.

The hydraulic valves essentially consist of:

- Cast iron
- Steel
- Aluminum
- Copper
- Plastics
- Electronics components and assemblies
- Elastomers

12.5 Recycling

Due to the high metal share, hydraulic products can mostly be recycled. In order to achieve an ideal metal recovery, disassembly into individual assemblies is required. The metals contained in electric and electronic assemblies can also be recovered by means of special separation procedures.

13 Extension and modification

The hydraulic valve must not be modified.

13.1 Optional accessories

Special tool for manual override

Table 4: Special tool

Valve type	Material no.
For all types with manual override N9	R900024943

Ordering address for accessories and hydraulic components

The addresses of our responsible sales organizations can be found on the Internet at www.boschrexroth.com and in [Chapter 16 List of addresses on page 47](#).

14 Troubleshooting

14.1 How to proceed for troubleshooting

- Always work systematically and purposefully, even when under time pressure. Random, thoughtless disassembly and changing of settings might result in the inability to determine the original cause of error.
- First get a general idea of the function of your hydraulic valve in conjunction with the overall system.
- Try to establish whether the hydraulic valve was functioning properly in conjunction with the overall system before the error first occurred.
- Try to determine any changes of the overall system in which the hydraulic valve is integrated, e.g.:
 - Changes in the application conditions or the area of application?
 - Have modifications (e.g. refitting) or repair works been carried out on the overall system (machine/system, electrical system, control) or on the hydraulic valve?
If yes: What were they?
 - Was the hydraulic valve and/or the machine used as intended?
 - How did the fault become apparent?
- Try to get a clear idea of the cause of error.

14.1.1 Fault table for hydraulic valves and pressure switches

Hydraulic valves and pressure switches are usually not sensitive to faults if the prescribed application conditions and hydraulic fluid quality are complied with.

Fault	Possible cause	Remedy
Hydraulic valve does not switch	Lack of pilot pressure	Check and/or reapply pressure at the ports.
	Spool is jammed due to contamination	Try to release the spool, if available, by operating the manual override, see Chapter 8.2 Operating the manual override on page 30 If the manual override is stiff, disassemble the hydraulic valve and replace it with a new hydraulic valve.
External leakage	Seals at connection surface damaged	Remove the hydraulic component and replace the seals, see Chapter 10.3 Repair on page 35
	Other leakage	Replace the hydraulic valve.

Following faults due to contamination, it is – in addition to the repair – essential to check the hydraulic fluid quality and improve it, if necessary, by suitable measures such as flushing or the installation of additional filters.

The following fault table is only relevant for hydraulic valves with electric control.

NOTICE	<p>Defective hydraulic valves with short-circuit!</p> <p>Defective hydraulic valves with electric short-circuit may cause damage in the system.</p> <ul style="list-style-type: none"> - Secure the hydraulic valves by means of an electric fuse according to the maximum current consumption. - Exchange hydraulic valves with short-circuit.
---------------	--

Table 5: Electrical faults

Fault	Possible cause	Remedy
Hydraulic valve does not switch	Electrical connection interrupted	Check whether the electrical plug-in connectors are correctly and completely mounted.
	Cable break	Replace connection cable.
	Electrical defect in the solenoid coil	Replace the solenoid coil; please contact our Industrial hydraulics service, see ↔ Chapter 16 List of addresses on page 47
	Connector defective or damaged	Replace the connector.

Table 6: Additional fault table for hydraulic valves with spool position monitoring

Fault	Possible cause	Remedy
No signals from spool position monitoring	Electrical connection interrupted	Check whether the electrical plug-in connectors are correctly and completely mounted.
	Cable break	Replace connection cable.
	Connector defective or damaged	Replace the connector.
	Spool position monitoring or pressure switch defective	Replace hydraulic valve and/or pressure switch.



If you were unable to remedy the error, please contact us at one of the addresses that you can find in [↔ Chapter 16 List of addresses on page 47](#).

15 Technical data

For the technical data of your hydraulic valve and/or pressure switch please refer to the data sheet.

16 List of addresses

Contacts for service and spare parts

Bosch Rexroth AG
Industrial Hydraulics Service
Bürgermeister-Dr.-Nebel-Straße 8
97816 Lohr am Main
Germany

Phone +49 (0) 9352/40 50 60

E-mail service@boschrexroth.com

For service representatives in your area outside of Germany, please refer to
➔ www.boschrexroth.de

Headquarters

Bosch Rexroth AG
Zum Eisengießer 1
97816 Lohr am Main
Germany

Phone +49 (0) 9352/18-0

E-mail my.support@boschrexroth.com

The addresses of our sales and service network and sales organizations can be found at ➔ www.boschrexroth.com

17 Index

A		R	
Abbreviations.	6	Recycling.	39
About this documentation.	5	Repair.	35
About this product.	17	Representation of information.	5
Accessories.	41	Required and amending documentation.	5
Assembling the hydraulic valve or pressure switch.	25	Required tools.	24
Assembly and installation.	23	Return to Bosch Rexroth AG.	39
B		S	
Before the assembly.	24	Safety instructions.	5, 7, 8
C		Product-specific.	9
Cleaning and care.	35	Scope of delivery.	15
Commissioning.	29	Spare parts.	36
D		Storage.	20
Damage to property and damage to the product	13	Storage of hydraulic components.	20
Disassembly and replacement.	37	Symbols.	6
Disposal.	39	T	
Documentation.	5	Technical data.	45
E		Transporting the hydraulic valve.	19
Environmental protection.	39	Troubleshooting.	43
Extension and modification.	41	U	
F		Unpacking.	23
Fault table.	43	Use	
H		Improper.	7
Hydraulically connecting the hydraulic valve.	26	Intended.	7
I		V	
Improper use.	7	Validity of the documentation.	5
Inspection and maintenance.	35		
Installation conditions.	23		
Intended use.	7		
L			
List of addresses.	47		
M			
Maintenance.	35		
Maintenance and repair.	35		
Materials used.	39		
O			
Obligations of the machine end-user.	12		
Operating the manual override.	30		
Operation.	33		
P			
Packaging.	39		
Painting the hydraulic valve.	23		
Product-specific safety instructions.	9		
Q			
Qualification of personnel.	8		

Bosch Rexroth AG
Zum Eisengießer 1
97816 Lohr a.Main
Germany
Tel. +49 9352 18-0
www.boschrexroth.com



RE07600-B