



INSTRUCTIONS  
MANUAL

# ADHESIVE MELTER **B4**

Published by:

**Focke Meler Gluing Solutions, S.A.**  
Pol. Arazuri-Orkoien, c/B, nº3 A  
E-31170 Arazuri - Navarra - Spain  
Phone: +34 948 351 110  
info@meler.eu - [www.meler.eu](http://www.meler.eu)



*Focke Group*

---

Edition May 2024

© Copyright by Focke Meler

All rights reserved. Its reproduction, diffusion or use by electronic or other means of all or any part of this document without the express authorization of its owner is strictly prohibited.

The specifications and information contained in this manual may be modified without prior notice.

The official language of this manual is only the English language. The remaining versions of the manual in other languages are mere translations without any official value or efficacy. In case of discrepancies or contradictions between the English version of the manual and any other version of the manual written in another language, the English version will prevail.

## TABLE OF CONTENTS

1. SAFETY GUIDELINES	1-1
<b>General</b>	1-1
<b>Symbols</b>	1-1
<b>Mechanical components</b>	1-2
<b>Electrical components</b>	1-2
<b>Hydraulic components</b>	1-2
<b>Pneumatic components</b>	1-2
<b>Thermal components</b>	1-3
<b>Materials</b>	1-3
<b>Noise emission declaration</b>	1-3
<b>Intended use</b>	1-4
<b>Limited use</b>	1-4
2. INTRODUCTION	2-1
<b>Description</b>	2-2
<b>Intended use</b>	2-2
<b>Limited use</b>	2-2
<b>Modes of operation</b>	2-2
<b>Hot-melt melter/applicator identification</b>	2-3
<b>Main components</b>	2-4
<b>Control panel</b>	2-5

<b>3. INSTALLATION</b>	<b>3-1</b>
<b>Introduction</b>	<b>3-1</b>
<b>Installation requirements</b>	<b>3-1</b>
Free space	3-1
Electrical Consumption	3-2
Compressed air	3-2
Other factors	3-2
Unpacking	3-3
Contents	3-3
<b>Mounting the equipment</b>	<b>3-3</b>
<b>Electrical power connection</b>	<b>3-4</b>
<b>Pneumatic connection</b>	<b>3-4</b>
<b>Hose and gun connection</b>	<b>3-4</b>
<b>Parameter Programming</b>	<b>3-5</b>
Programming working temperatures	3-5
Selecting the overheating value	3-6
Keeping a component on display	3-6
<b>External I/O connections</b>	<b>3-7</b>
Temperature ok	3-7
External Standby	3-8
Pump start/stop	3-8
<b>4. MELTER OPERATION</b>	<b>4-1</b>
<b>General information</b>	<b>4-1</b>
<b>Filling the tank</b>	<b>4-2</b>
<b>Starting up the melter/applicator equipment</b>	<b>4-2</b>
<b>Melter/applicator equipment displays</b>	<b>4-3</b>
Displaying the temperature for each component	4-4
Alarm displays	4-4
Operational pressure display and adjustment	4-5

<b>Temperature adjustment</b>	<b>4-5</b>
<b>Programming the applicator parameters</b>	<b>4-6</b>
<b>Setting the clock</b>	<b>4-7</b>
Programming the current day and hour	4-7
Programming equipment activation/deactivation	4-8
Disabling the equipment activation/deactivation program	4-8
Programming the equipment's standby function activation/deactivation	4-9
Disabling the equipment standby function programming	4-10
<b>Special function buttons</b>	<b>4-11</b>
<b>Pump start/stop control</b>	<b>4-12</b>
<b>By-pass valve regulation</b>	<b>4-12</b>
<b>Turning off the melting equipment</b>	<b>4-13</b>
<b>5. MAINTENANCE</b>	<b>5-1</b>
<b>External cleaning</b>	<b>5-1</b>
<b>System depressurization</b>	<b>5-3</b>
<b>Cleaning the tank</b>	<b>5-3</b>
Changing adhesive type.	5-3
Cleaning burnt adhesive	5-4
Emptying the tank	5-4
<b>Maintenance of the filters</b>	<b>5-5</b>
Changing the pump filter	5-5
Changing the inlet filter	5-6
<b>Pump maintenance (gear version)</b>	<b>5-7</b>
Inspecting for leaks	5-7
<b>Motor-gear maintenance (gear version)</b>	<b>5-7</b>
Cleaning the motor fan	5-7
Checking the lubricant	5-7
Recommended lubricant:	5-7
<b>Detaching the equipment from its base</b>	<b>5-8</b>

6. TECHNICAL CHARACTERISTICS	6-1
<b>General</b>	<b>6-1</b>
<b>Dimensions</b>	<b>6-2</b>
Melting unit	6-2
Base plate	6-2
7. ELECTRICAL DRAWINGS	7-1
8. PNEUMATIC DRAWINGS	8-1
<b>Components list (*)</b>	<b>8-1</b>
9. SPARE PART LIST	9-1
<b>A. TANK GROUP</b>	<b>9-3</b>
<b>B. PUMP GROUP</b>	<b>9-4</b>
<b>C. PNEUMATIC GROUP (for piston pump version)</b>	<b>9-5</b>
<b>D. ELECTRICAL COMPONENTS</b>	<b>9-6</b>
EC DECLARATION OF CONFORMITY	10-1

# 1. SAFETY GUIDELINES

## General

The information contained in this section applies not only to everyday equipment operation, but also to any procedure carried out on it, whether for preventive maintenance or in the case of repairs and the replacement of worn out parts.

It is very important to observe the safety warnings in this manual at all times. Failure to do so may result in personal injury and/or damage to the equipment or the rest of the installation.

Before beginning work on the equipment, read this manual carefully, and in case of any doubt, contact our Technical Service Center. We are available for any clarification that you might need.

Keep manuals in perfect condition and within reach of personnel that use the equipment and perform maintenance on it.

Also provide necessary safety material: appropriate clothing, footwear, gloves and safety glasses.

In all cases, observe local regulations regarding risk prevention and safety.



## Symbols

The symbols used on both the melter/appliator equipment and in this manual always represent the type of risk we are exposed to. Failure to abide by a warning signal may result in personal injury and/or damage to the equipment or the rest of the installation.

**Warning:** Risk of electrical shock. Carelessness may produce injury or death.



**Warning:** Hot zone with high temperatures. Risk of burns. Use thermal protective equipment.



**Warning:** System under pressure. Risk of burns or particle projection. Use thermal protective equipment and glasses.



**Warning:** Important information for the correct use of the system. May include one or several of the previous hazards, and therefore must be kept in mind to avoid damage and injury.



**Warning:** Dangerous area. Risk of entrapment. Carelessness may produce injury or death.



## Mechanical components



The hot-melt installation, which is installed to this device, requires moving parts that can cause damage. Use the equipment correctly, and do not remove the safety guards while the equipment is in operation; prevent the risk of possible entrapment due to moving mechanical parts.

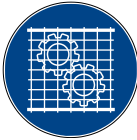

Do not use the equipment if the safety devices are not in place or appear to be inadequately installed.

For maintenance or repair operations, stop the movement of moveable parts by turning off the main switch.

The device has no moving mechanical parts, so it does not pose risks to consider in this section.



## Electrical components

The system works with single-phase or three-phase current of a certain power. Never handle the equipment with the power connected, as this may result in powerful electrical shocks.



The installation must be correctly grounded.

The installation's power cable conductors must match the required electric current and voltage.

Periodically inspect the cables to check for crushing, wear and tear, as well as to prevent tripping and falls as a result of their placement.

Although the system meets EMC requirements, it is inadvisable to use devices that transmit high levels of radiation, i.e., mobile phones or soldering equipment in their vicinity.



## Hydraulic components

As this is a pressurized system, precautions related to this type of equipment must be observed.

Before each operation, always make sure that the adhesive circuit is completely free of pressure. There is a high risk of hot particle projection, along with the corresponding danger of burns.

Use caution with the residual pressure that may remain in the hoses when the adhesive cools. When reheated, there is a risk of hot particle projection if the outputs are left open.

## Pneumatic components



Some equipment uses compressed air to 6 bar pressure. Before any manipulation, please ensure that the circuit has lost fully air pressure. The risk of projection of particles at high speed can cause injury to a certain severity.

Extreme precautions with the residual pressure that could be contained in the circuit, before disconnecting any pneumatic feeding tube.



## Thermal components

The entire system works with temperatures that can exceed 200°C (392°F). The equipment must be operated using adequate protection (clothing, footwear, gloves and protective glasses) that completely cover exposed parts of the body.

Keep in mind that, due to the high temperatures reached, the heat does not dissipate immediately, even when the power (in this case, electric) source is disconnected. Therefore, use caution, even with the adhesive itself. It may remain very hot, even in a solid state.

In case of burns:

1. If the burn is the result of contact with melted adhesive, do not try to remove the adhesive material from the skin. Do not try to remove it once it has solidified either.
2. Cool the affected area down immediately with lots of cold and clean water.
3. Seek medical attention as soon as possible either from the company's medical service or the nearest hospital. Provide the medical staff with the Safety Information Sheet of the adhesive.



## Materials

Meler systems are designed for use with hot-melt adhesives. They should not be used with any other type of material, and especially not with solvents, which may cause personal injury or damage to internal system components.

Some units are specifically designed to use polyurethane reactive (PUR) hot-melt adhesives. Using PUR on a unit that is not prepared for that purpose may cause severe damage to the unit.

When using adhesive, follow the corresponding guidelines found in the Technical and Safety Sheets provided by the manufacturer. Pay special attention to the advised work temperatures in order to prevent adhesive burning and degradation.

Ventilate the work area adequately in order to remove the vapors produced. Avoid the prolonged inhalation of these vapors.

Always use original Meler components and replacement parts, which guarantee the correct system operation and service.



## Noise emission declaration

The A-weighted emission sound pressure level ( $L_{pA}$ ) of the unit in operation does not exceed 70 dB(A) under any circumstances.

The maximum C-weighted sound pressure level ( $L_{pCpeak}$ ) and the A-weighted sound power level ( $L_{WA}$ ) do not exceed values worthy of mention and thus do not represent a specific risk that must be taken into account.



### Intended use

The equipment are designed to be used in the following conditions:

- Hot-melt adhesive fusion and pumping at temperatures up to 200 °C (392 °F). Consult with Meler technical service to operate with higher working temperatures.
- Use of equipment with Meler accessories.
- Installation of equipment according to the security regulations currently in force and the instructions provided in this manual (anchoring, electrical connection, hydraulic connection, etc).
- Use of equipment in non-explosive, non-chemically aggressive environments.
- Use of equipment following the safety instructions indicated in this manual, as well as on the labels accompanying the equipment, using adequate means of protection during each mode of operation.



### Limited use

The equipment should never be used under the following conditions:

- Use with reactive polyurethane or any other material that might cause safety or health risks when heated.
- Use of equipment in environments where cleaning is necessary using water jets.
- Use of equipment to heat or melt food products.
- In potentially explosive atmospheres, aggressive chemical environments or outdoors.
- Use or operation without adequate safety protection.
- If the person in question does not have the necessary training to use the unit or to apply all of the necessary safety measures.



**Note:** Do not modify the equipment or use components that were not supplied by Meler. For any modification of a component of the equipment or part of the installation, you must firstly consult the After-Sales Service

## 2. INTRODUCTION

In this manual you will find information about the installation, use and maintenance of the hot-melt adhesive melter/appliator in meler's B4 units.

This unit has a tank of 4 liters capacity in two versions: piston and gear pump.

It is designed to be used commonly in manual applications with EVA based adhesives or simple automatic applications where if a gear pump is used, speed regulation it is not necessary.



## Description

### Intended use

'B4' hot-melt melters/applicators are designed to be used in the following conditions:

- Hot-melt adhesive fusion and pumping at temperatures up to 200°C
- Use of hot-melt melters/applicators with 'meler' accessories
- Installation of hot-melt melters/applicators according to the security regulations currently in force and the instructions provided in this manual (anchoring, electrical connection, hydraulic connection, etc)
- Use of hot-melt melters/applicators in non-explosive, non-chemically aggressive environments
- Use of hot-melt melters/applicators following the safety instructions indicated in this manual, as well as on the labels accompanying the equipment, using adequate means of protection during each mode of operation.

### Limited use

The 'B4' hot-melt melters/applicators must be used for their intended uses and never in the following conditions:

- Use with adhesives or any other material that might cause safety or health risks when heated.
- Use of hot-melt melters/applicators in environments where cleaning is necessary using water jets.
- Use of hot-melt melters/applicators to heat or melt food products.
- Use or operation without adequate safety protection.

### Modes of operation

The 'B4' series hot-melt melters/applicators may be used in all of the following modes:

**Work mode**\_The melting equipment keeps the hot elements at the temperature indicated on the display, which has been preselected to the desired value. The pump-piston or motor set remains active, on standby to receive the consumption request by the opening of one or more applicator guns.

#### In gear pump versions:

manual control\_The pump motor is started by means of the switch in 'MANUAL' position.

automatic control\_Switch is in 'AUTO' position. The pump motor is started by means of an external signal contact, usually a hand gun trigger switch.

**Standby mode**\_The melting equipment remains on standby status, with the temperatures of the elements at a value (which may be programmed) that is below the preselected value. The pump-motor remains deactivated.

**Alarm mode**\_The melting equipment detects a malfunction and warns the operator about the event. The pump-motor remains deactivated.

**Stop mode**\_The melting equipment remains off, no elements are heated and the pump-motor assembly is deactivated. However, the electrical and pneumatic power from the grid, if any, are still supplied to the equipment.

### Hot-melt melter/appliator identification

When placing orders for replacement parts or requesting help from our service center, you should know the model and reference number of your hot-melt melter/appliator.

This and other technical information will be found on the identification plate located on the side of the lower part of the hot-melt melter/appliator.

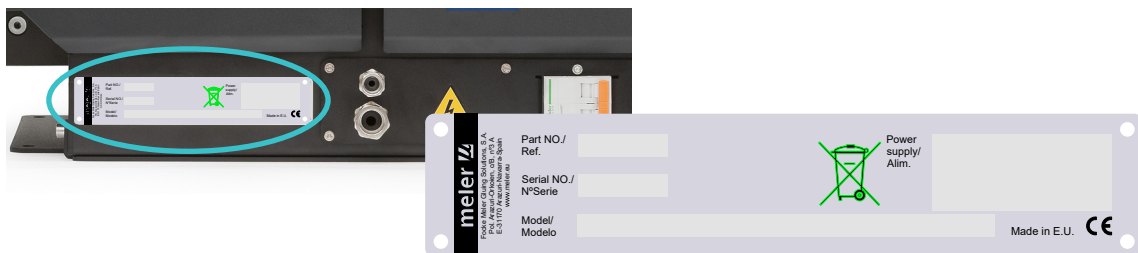

### Main components

- 1. Front control card
- 2. Power switch and input power supply
- 3. Pressure regulator (piston version)
- 4. Pressure gauge (piston version)
- 5. 'MANUAL / 0 / AUTO' mode switch (gear version)
- 6. Tank access cover
- 7. Hose output distributor (up to 2 hydraulic connections)
- 8. Hose-gun electrical connections
- 9. Compressed air input (piston version)
- 10. Motor start-stop connector (gear version)



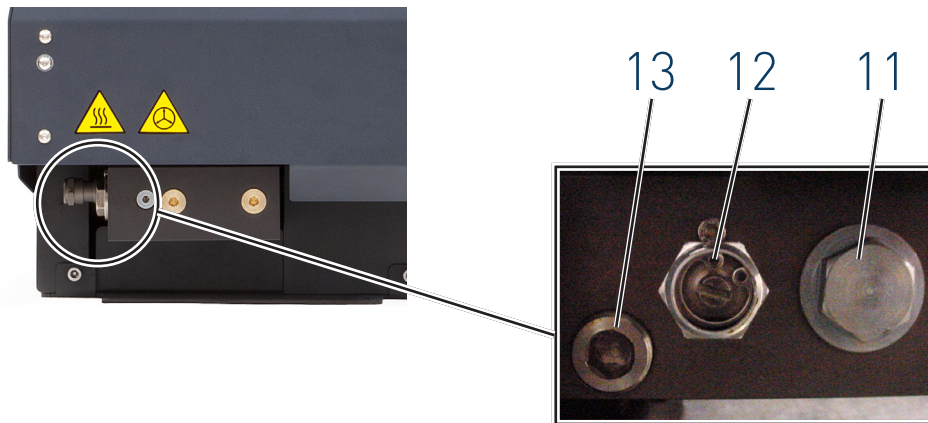

- 11. Pump filter
- 12. Purge valve
- 13. Pressure relief valve (gear pump version)

**Control panel**

- 1. Tank indicator led
- 2. Gun indicator led
- 3. Temperature set point
- 4. Actual temperature
- 5. ON/OFF switch
- 6. Standby function
- 7. Temperatures ok led
- 8. Timer programming
- 9. Up/Down arrows for element selection
- 10. Up/Down arrows for value modification
- 11. Hose indicator led



This page is intentionally left blank.



## 3. INSTALLATION

**Warning:** The melters/applicators are equipment with current technology and with certain foreseeable risks. Therefore, only allow qualified personnel with sufficient training and experience to use, install or repair this equipment.



### Introduction

The 'B4' melters/applicators are delivered with all the materials necessary for their installation. However, some components must be provided by the user himself, according to the location and connections in each particular installation:

- Anchoring screws for the melter/applicator equipment
- Power cord and plug for electrical power
- Pneumatic conduct and connection to the compressed air system (piston pump version)
- Multicore cable for external electrical control
- Optionally, a gas ventilation system

### Installation requirements

Before installing 'B4' melter/applicator equipment, we must make sure that the space assigned to it permits installing, connecting and using the entire system. Similarly, we must check to see that the electrical and pneumatic supplies meet the necessary requirements of the melter/applicator equipment being installed.

#### Free space

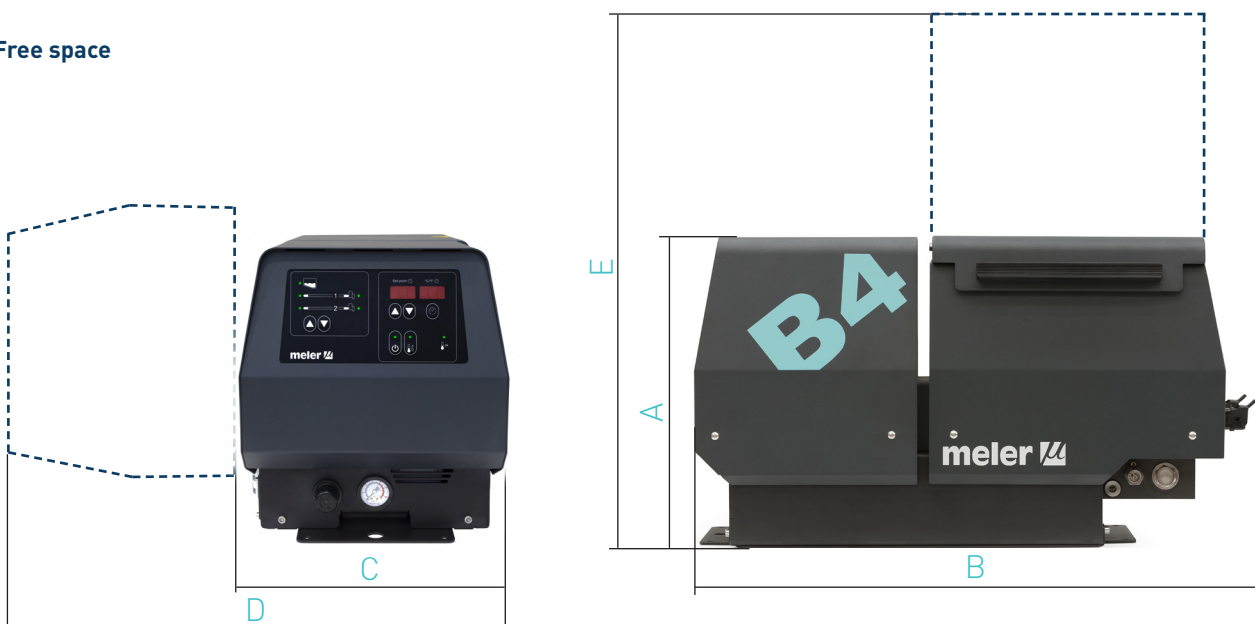

Item	Description	Dimensions
A	EQUIPMENT LENGTH	354 mm
B	EQUIPMENT WIDTH	630 mm
C	EQUIPMENT HEIGHT	320 mm
D	EQUIPMENT LENGTH WITH ELECTRICAL CABINET OPEN	620 mm
E	EQUIPMENT HEIGHT WITH LID OPEN	635 mm

### Electrical Consumption

In order to install a 'B4' melter/appliator, we should take into consideration the total consumption of the installation, including the consumption of the installed hoses and guns.

Before connecting, make sure that the voltage that is being connected to the melter/appliator is the correct one appearing on the equipment's characteristics plate.

Connect the machine and check to see if it is well grounded.



**Warning:** Risk of electrocution. Even when the equipment is turned off, voltage remains in the intake terminals, which may be dangerous during internal equipment manipulations.

Install a power switch for disconnecting the melter/appliator equipment from the electrical network.

### Compressed air

To install 'B4' melters/appliators -piston pump version-, it is necessary to have a dry, non-lubricated compressed air system with a maximum pressure of 6 bar.

The applicator's internal pneumatic equipment is able to work with a minimum of 0.5 bar, however, pressure lower than this will cause intermittent operational anomalies.

The air consumption is according to the number of stroke made by the pump cylinder, which in turn depends on the adhesive consumption during the application. It is therefore necessary to estimate this consumption in all cases. Generally speaking, we can provide as a maximum consumption value 40-50 l/min for a pressure of 6 bar at maximum pump speed.

### Other factors

While installing 'B4' melters/appliators, other practical considerations should be kept in mind:

- Keep the load opening accessible for comfortable melter/appliator filling

- Position the melter/appliator equipment in such a way that you can easily see the front panel display where temperatures and possible alarm signals are shown
- As much as possible, try to avoid unnecessarily long hoses that result in elevated electrical energy consumption levels and pressure drops
- Do not install the melter/appliator equipment beside powerful heat or cooling sources that may have distortional effects upon its operation
- Avoid melter/appliator vibrations
- Make sure that the melter/appliator maintenance areas (filter, purging valve, tank interior, etc.) are easily accessible

### Unpacking

Before proceeding with the installation of the melter/appliator, it should be removed from its location on a pallet and examined in order to detect any possible breakage or deterioration. Communicate any defect, even to the outer packing materials, to your 'melter' Representative or to the Main Office.

### Contents

The 'B4' packing materials may contain accessories that form part of the same order. If this is not the case, the following are the standard components that accompany the melter/appliator:

- Instruction manual
- Guarantee card

## Mounting the equipment

'B4' melters/appliators include a mounting base plate for easy mounting.

The base plate allows you to remove and position the melter/appliator equipment easily, without having to touch the fastening screws. To mount the base plate, place it on the machine bench and adjust its position. Mark and drill the four holes for the base plate's M8 fastening screws. The holes may be threaded or non-threaded, depending on the bench to which they are being attached.

**Warning:** Make sure that the bench where the base plate is fastened is level, free from vibrations and is able to support the weight of the equipment in addition to the full tank load.

Once the base plate is fastened in place on the bench, the melter/appliator should be mounted on top of it.

Insert the fastening tabs of the unit and put the four screws to fix it.

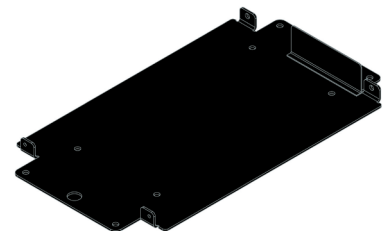

### Electrical power connection



'B4' melters/applicators are designed to be connected to the electrical power supply in 1-phase 230 VAC plus neutral, depending on their power consumption:

A good ground connection is required in all cases.

Consumption figures, according to melter/applicator and output configuration, are included in the table.

Unit	Pump	No. Outputs	Max. connecting power	
			unit only	with outputs installed
B4	piston	2	8,7A	16A
	gear	2	9,7A	16A

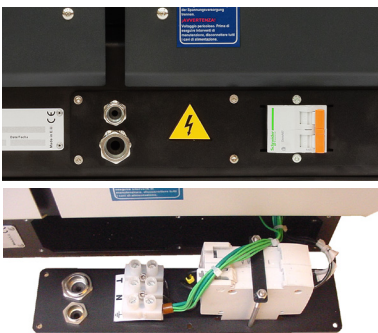

**Warning:** Risk of electrical shock. Carelessness may cause injury or death.

Remove six screws that fix the plate with the power switch to the unit at the left side of the unit. Thread the power cord (Ø6-12 mm) through the electrical wall bushing Pg 13.5 and fasten it to the inside anchor, making sure that the cord remains well fixed and allows the plate to be mounted again.

Connect each wire in the power cord to its corresponding place on the power intake terminals block.

### Pneumatic connection

In piston pump version, before connecting the pneumatic power to the melter/applicator, make sure the pressure regulator is completely closed. To do this, turn the regulator handle located on the equipment base next to the pressure gauge counterclockwise as far as it will go.

Connect the plant air supply (max. 6 bar) to the melter/applicator intake using flexible tubing with an outside diameter of 6 mm. The equipment is provided with a quick coupling for this purpose.

Activate the air supply to pass and turn the pressure regulator clockwise. Adjusting to 1 bar of pressure is enough for checking the pump operation.

The pump will not operate and the pressure gauge will show 0 bar until the melter/applicator and the hoses-guns connected to it reach the correct temperature.

Once the pump operation has been checked, you may adjust the pressure to the operational value you wish.

### Hose and gun connection

'B4' melters/applicators use standard 'meler' components. The entire range of hoses and 'classic', 'compact' and 'manual' guns may be connected to this equipment.

Up to two hose-gun outputs may be connected to B4 melters/applicators with only one pump installed. These outputs are identify with number 1 and 2, corresponding to the same channels on the control board.



**Warning:** When connecting hose-gun outputs, verify that the connected power is not above the maximum allowable power for each output.

Caution:

- In order to identify each hose-gun, electrically connect them to the connector with the same number as the output they use.
- It is preferable to use couplings at a 45° or 90° angle to minimize the space the hoses occupy. Using straight couplings usually results in curves with very small radii that may damage the inside of the hose.
- Save the screw-on caps that are removed from the distributor in order to connect a hose. They may be necessary in the future if a hose is removed from its location.
- Perform the electrical hose and gun connections with the equipment turned off. Failing to do so may result in electrical defects in the connection and the appearance of alarm messages on the melter/ applicator display.

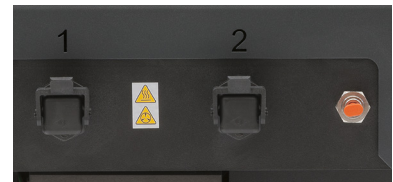
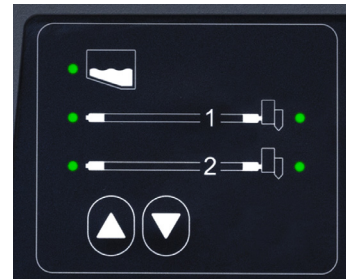

## Parameter Programming

Once the melter/applicator and its components are installed, you will need to program the operational parameters appropriate for the specific application that will be performed.

'B4' melters/applicators simplify this task as much as possible, allowing the operator to modify only those parameters that are necessarily variable for each application.

Among the various parameters, it is necessary to program the set point temperature values for each component connected and the value for overheating warnings. There are two other parameters (weekly start-up and shut-down programming and the standby temperature value) left to program in advanced systems, although the factory default values are perfectly valid for operational purposes.

### Programming working temperatures

The melters/applicators leave the factory with the following set point temperatures:

- 160 °C (320 °F) for the tank
- Disconnected (OFF) for hoses and guns.

The general process for modifying set up temperature values for any component is described below.

1. Select the component for which you wish to modify the value with the up-down arrow.

The corresponding LED will blink quickly.

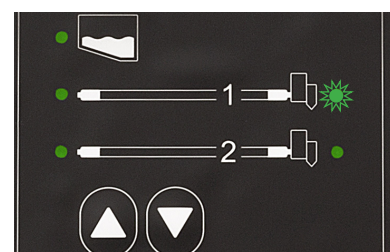



- Using the up-down arrow under the display, select the desired value for the set point temperature.
- After ten seconds, the LED will stop blinking and the display will change by default to the set point temperature, saving the changed data.

This simple process must be repeated for each one of the components installed on the melter/applicator.

### Selecting the overheating value



- Press the buttons with the clock symbol and the down arrow under the display at the same time to enter the special menu. The choice of display units (°C or °F) will appear on the display.
- Using the up arrow for element selection, we advance to the next screen where the overheating symbol appears.
- Select the desired value with the up-down arrow under the display.

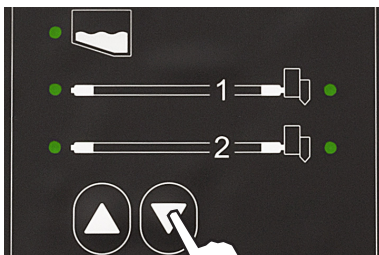

The value displayed corresponds to the increase in real temperature over the set point temperature permitted without activating the alarm message.

- Use the up arrow for element selection to advance to the next screen.
- Exit the special menu using the down arrow for element selection and the tank temperatures will once again be displayed.

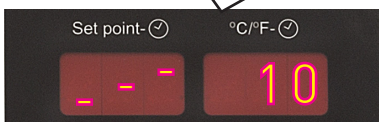

All the special menu values will be saved.

### Keeping a component on display

By default, the main display shows the tank temperatures. However, it is possible to display indefinitely the temperatures of any component for analysis or tracking.

- Select the component you wish to see permanently with the up-down arrow for element selection.

The corresponding LED will blink rapidly.

- Hold the arrow button down for two seconds, selecting the desired component.
- The display will now remain on the selected component, without changing.

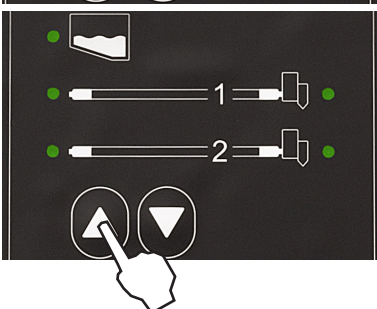
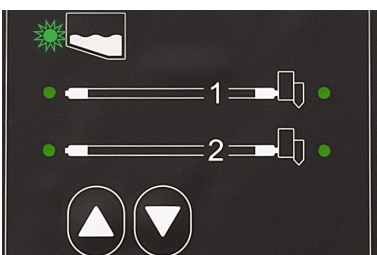

- Simple press any up-down arrow button again to restore the default display (tank).

## External I/O connections

The melter/applier's input and output signals (I/O) allow it to communicate with the main machine simply and directly.

There are three signals that may be used to communicate with the main machine:

- **Temperatures ok**\_an output from a non-voltage contact that communicated to the main machine (or to a warning light beacon) that all the system temperatures have reached 3° below their set point value (and the delay time have finished) during start-up, or that their real value is not 20°C below their set point value during operation.
- **External Standby**\_control input from the standby mode, via a non-voltage contact. The standby function is connected with a closed contact; an open contact disconnects it.
- **Pump start/stop** in gear pump version control input of motor start and stop mode, via a non-voltage contact. This signal is normally control by a trigger switch on the hand gun used.

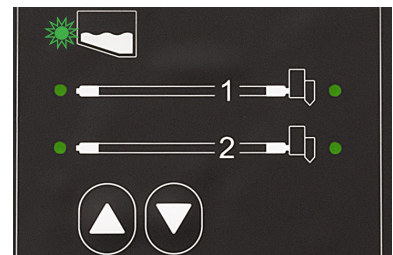

**Warning:** Risk of electric shock. Carelessness may cause injuries or death.



### Temperature ok

- If only this signal will be connected, use a 0.5 mm<sup>2</sup> two-wire cable.

Install an electrical wall bushing Pg9 on the equipment base plate next to the electrical supply input.

- Remove six screws that fix the plate with the power switch to the unit at the left side of the unit. Thread the power cord (Ø4-8 mm) through the electrical wall bushing Pg9 and fasten it to the inside anchor, making sure that the cord reaches the control card connector at the position where it will be installed.
- Remove the connector from the card and connect the two cable wires to their corresponding connector terminals:

- 1 contact NO
- 3 contact NO

- Reconnect the card connector.

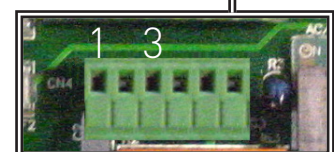
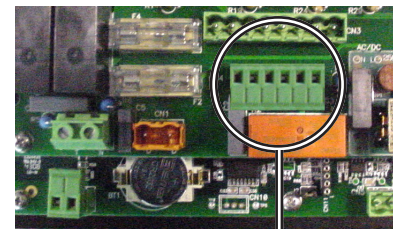

5. Make sure that the cable is well connected and that its path through the electrical cabinet presents no risks of snagging, being cut or any other accidental deterioration.



**Warning:** It must be connected to 24 AC or DC voltage. If you connect this signal to 230V load current cannot be less than 50mA.

**External Standby**

1. If this is the only signal being connected, use 0.5 mm<sup>2</sup> two-wire cable.

Install an electrical wall bushing Pg9 on the equipment base plate next to the electrical supply input.

2. Remove six screws that fix the plate with the power switch to the unit at the left side of the unit. Thread the power cord (Ø4-8 mm) through the electrical wall bushing Pg9 and fasten it to the inside anchor, making sure that the cord reaches the control card connector at the position where it will be installed.

3. Remove the connector from the card and connect the two cable wires to their corresponding connector terminals:

1 contact NO

2 contact NO

4. Reconnect the card connector.

5. Make sure that the cable is well connected and that its path through the electrical cabinet presents no risks of snagging, being cut or any other accidental deterioration.

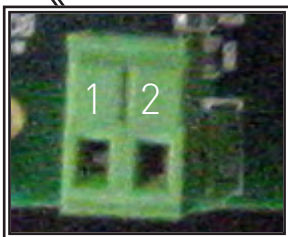
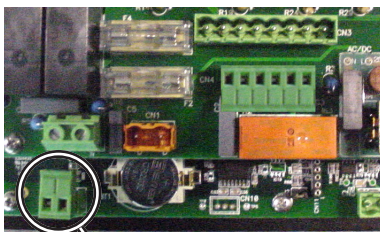

**Pump start/stop**

In gear pump versions, at the rear panel of the unit there are two rounded connectors, each for every hose-gun output, that allow to control the start/stop of the motor.

This connector usually belongs to the hand hose-gun assembly so it is only necessary to connect it to the unit.

If it is necessary to control the motor by means of an external signal, contacts 1 and 4 of the connector must be installed. Use a 0.5 mm<sup>2</sup> two-wire cable for that purpose.

To use this signal, pump switch at the front of the unit must be placed in 'AUTO' position.





## 4. MELTER OPERATION

In this section we will introduce the method for using the melter/appliator. Although its operation is very simple, it should not be used by untrained personnel.

**Warning:** Improper use may cause damage to the machine or injury and even death to the person using it.



### General information

There are three large groups of components with thermal control in a hot-melt installation: the melting unit, the transport hoses and the melter/appliator guns. All of these are controlled from the front panel of the melter/appliator equipment.

The first large group is the tank-distributor-pump assembly. They form a single unit with a common temperature control and the same set point value. Therefore, when you program a value for the tank, for example 170°C, the distributor and the pump takes on this same value.

The second group is the hose group. These are identified on the front panel from No. 1 and No. 2 and by a picture of the corresponding hose. Each has its own set point value.

The third group is the gun group. These are identified on the front panel from No. 1 and No. 2 and by a picture of the corresponding gun. Each has its own set point value.

The hose and gun numbers are automatically assigned to the hose/gun channel they are connected to on the rear part of the melter/appliator.

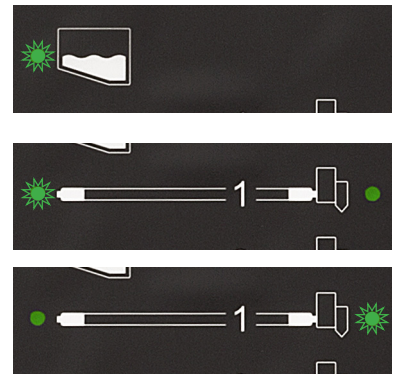



## Filling the tank

To fill the tank:

1. Open the tank lid.
2. Use a shovel or a ladle to fill the tank with adhesive. Do not fill the tank above the loading opening level. The lid must be able to close normally.

**Warning:** Risk of burns. Always refill using protective gloves and glasses.

3. Close the lid when you have finished refilling the tank.

**Warning:** Before refilling the tank, make sure that the adhesive is the same type as that already in the tank. Mixing different types of adhesives can cause damage to the melter/appliator equipment.

'B4' melter has a tank capacity of 4 liters (4 kg for an adhesive density of 1 g/cc).

## Starting up the melter/appliator equipment

Before starting up the melter/appliator equipment, it is necessary to check to see if the unit has been correctly installed and all its input/output and accessory connections are correctly established.

It is also necessary to make sure that the equipment has been filled with adhesive and that the operational parameters have been programmed.

To start:

1. Connect the melter/appliator's power switch.

If the control card was turned off the last time the machine was disconnected, it will remain tuned off when the machine is started up again (time display).

If the control card was on the last time that the machine was disconnected, it will turn on when the machine is started up again.

2. Press the ON/OFF button on the control card to turn it on, if it not already activated.

By default, the set point and real temperature values shown are those corresponding to the tank.

The tank heating control LED (green) will light up and the tank will begin to heat.

Once it has reached 3° below the programmed temperature (set point) of the tank, a programmable delay timer starts until, guaranteeing fusion, the pump receives permission to operate and the signal will be sent to the main machine, indicated by the two corresponding (green) LEDs.

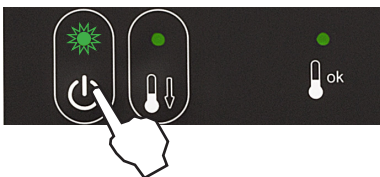

While the system is running the delay timer both LEDs remains blinking until the programmed time value has been reached. If then, any other element has not reached 3° below its temperature setting point, the LEDs turn off.

If the system is shut down, for any possible mode, when it is turning on the delay timer only starts again if the tank temperature is 20° below setting point.

3. In piston pump version check the pressure gauge to assure a correct working pressure. Values below 0.5 bar can cause failures in the pump movement.



### Melter/appliator equipment displays

'B4' melters/appliators have two displays built into their control panel, with three sets of 7 segments each for displaying the temperature values (set point and real temperature), programmable parameters and alarms.

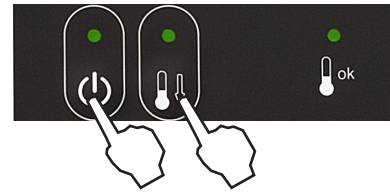

LED display	Component heating	Component status
constantly lit	constant	low temperature
blinking slowly	as needed (according to PID parameters)	temperature near set point
blinking rapidly	programming or display	change in set point values
off	not heating	temperature reached

They are equipped with LED indicators to display the heating of each component, as well as the pump activations and the main machine connection signal.

They are also equipped with LEDs indicating equipment connection/disconnection and standby function connection/disconnection:

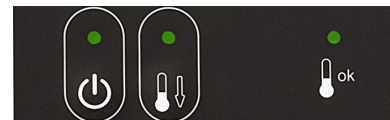

LED display	On/off	Standby
constantly lit	turned off unit	function activated
blinking slowly	deactivation programmed for the current day	activation programmed for the current day
blinking rapidly	activation/deactivation programming mode	activation/deactivation programming mode
off	unit in operation	function deactivated
simultaneous intermittence from both leds	timing in progress, once the tank has reached its set point temperature	

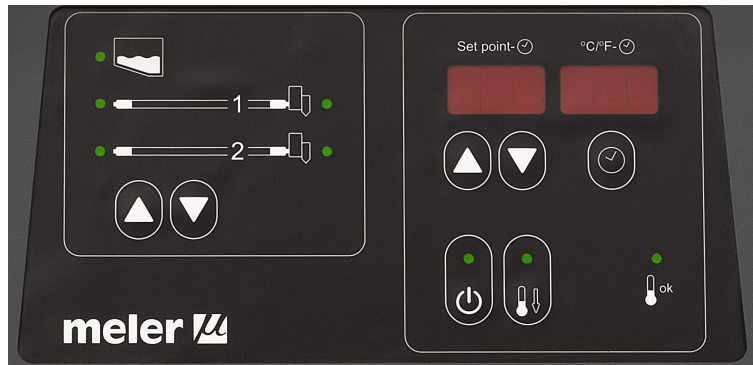

**Displaying the temperature for each component**

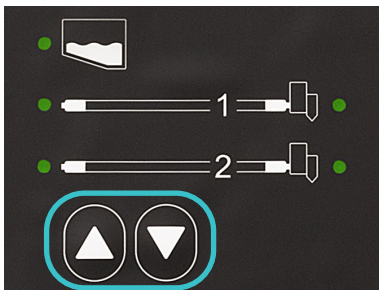

The temperature may be displayed for each component (tank, distributor and each hose and gun) by selecting the component with the cursor.

Press the up-down arrow for element selection until the desired component is displayed.

After 10 seconds, the display will return to the default component (the tank).

If you wish to keep the component displayed permanently, press and hold the up-down arrow for 2 seconds while selecting the chosen element.

The display sequence is the following:

tank←hose1←gun1←hose2←gun2

tank→hose1→gun1→hose2→gun2

To remove a component from permanent display, simply press either of the up-down arrows.

**Alarm displays**



'B4' series melter/appliator equipment tell the user when a malfunction has occurred in the unit, sending warning messages that may be seen on the control panel display.

When an alarm appears, the control unit takes a series of steps to protect the unit. Simply correct that malfunction and the control unit will reactivate the equipment functions.

Code	Source	Actions		
		Heating	Pump	Main machine signal
Err 0	tank broken sensor	only tank	off	off
Err 1	hose 1 broken sensor	only hose 1	off	off
Err 2	gun 1 broken sensor	only gun 1	off	off
Err 3	hose 2 broken sensor	only hose 2	off	off
Err 4	gun 2 broken sensor	only gun 2	off	off
Err 100	tank overheating	all components off	off	off
Err 101	hose 1 overheating	all components off	off	off
Err 102	gun 1 overheating	all components off	off	off
Err 103	hose 2 overheating	all components off	off	off
Err 104	gun 2 overheating	all components off	off	off

Standby function does not generate any alarm.

If a temperature sensor is broken, the system heats all the elements except the one where the failure is located.

In case of overheating the system cuts off immediately the damaged element. After three minutes if the failure continues all the system will be shut down. After repairing the failure the system starts heating normally.

### Operational pressure display and adjustment

In piston pump version the air pressure with which the pneumatic pump control device works with is shown on the pressure gauge located on the base of the melter/applicator. The pressure must be adjusted according to the application needs.

**Warning:** Values below 0.5 bar may cause erratic pump action. Never surpass 6 bar of pressure. The multiplying effect of the pump elevates the hydraulic pressure to dangerous levels for component operation.

To regulate the pressure, pull the handle out and turn the regulator clockwise (+) or counterclockwise (-) as needed.



### Temperature adjustment

The melters/applicators leave the factory with the following set point temperature values:

- 160 °C (320 °F) for the tank and manifold
- 150°C for the hoses and 160°C for guns
- °C displayed
- Overheating value: 20°C
- Standby value: 40%
- Delay time: 10 min
- On/off and stanby programming: ON

The general process for adjusting the temperatures of each components is described below.

1. Select the component whose value you wish to modify using the up-down arrow for element selection.

The corresponding LED will blink rapidly.

2. Select the desired set point temperature value with the up-down arrow under the display. Below 40°C the set point value displays 'OFF' canceling the heating of that element.

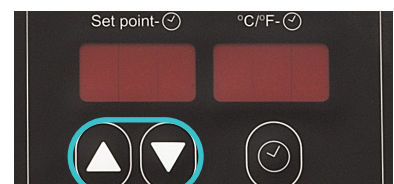
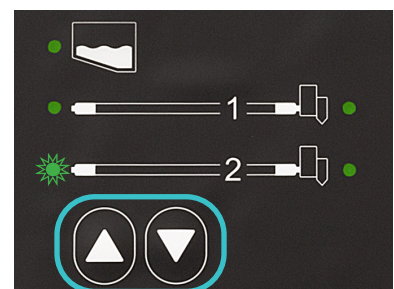

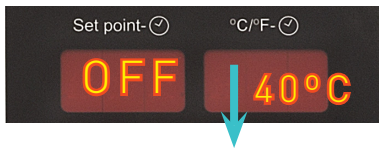

3. After ten seconds, the LED will stop blinking and the display will show the tank's set point temperature value by default, saving the modified data.

This simple procedure should be repeated for each of the components whose set point temperature value you wish to modify.

### Programming the applicator parameters



1. Simultaneously press the buttons with the clock symbol and the down arrow to enter the special menu.

The choice of temperature display units (°C or °F) will appear on the display.

2. Select the desired value using the up-down arrow under the display.

3. Use the up arrow for element selection to move to the next display where the overheating symbol appears. — — —

4. Select the desired value (between 10 and 25) using the up-down arrow under the display.

The value shown corresponds to the increase in real temperature allowed over the set point temperature without activating the alarm message.

5. Use the up arrow for element selection to go to the next display where the standby function symbol appears. — — —

6. Use the up-down arrow under the display to select the desired value (between 25 and 55).

The value shown corresponds to the percent decrease in the real temperature compared to the set point temperature that will occur when this function is activated.

7. Use the up arrow for element selection to go to the next display where delay time value appears.

8. Use the up-down arrow under the display to select the desired value (between 0 and 60 min).

9. Use the up arrow for element selection to return to the initial parameter.

10. For any parameter, the down arrow for element selection may be used to exit the special menu and display the tank temperatures once again.

To record any parameter, you must always move to the next parameter, using the right arrow.

## Setting the clock

'B4' melters/applicators are equipped with a weekly programmable system controlling equipment connection and disconnection and activating and deactivating the standby function.

Before programming these functions, it is necessary to introduce into the control unit data corresponding to the day and hour used to execute these programs.

### Programming the current day and hour

1. Press the button with the clock symbol.

A '0' will appear on the display, indicating the program for current day and hour information.

2. Press the button with the clock symbol once again.

On the left display, you will see the time with a dot, indicating that this is the value that may be modified, while the minutes appear on the second display.

3. Use the up-down arrow under the display to select the desired value.

4. Press the button with the clock symbol once again.

Now the dot will appear on the right display.

5. Use the up-down arrow under the display to select the desired value.

6. Press the button with the clock symbol once again.

A number appears, indicating the day of the week (1- Monday / 7- Sunday).

7. Use the up-down arrow under the display to select the desired value.

8. Press the button with the clock symbol once again.

The '0' program appears once again.

9. Pressing either the up or the down arrow for element selection will exit this program and return to the tank temperature display.



**Programming equipment activation/deactivation**

You may program an activation and a deactivation time for every day of the week, from Monday (1) to Sunday (7).

Time is expressed in 15 minute increments, so we cycle from 10.0 (10 hours and 0 minutes) to 10.1 (10 hours and 15 minutes) to 10.2 (10 hours and 30 minutes) to 10.3 (10 hours and 45 minutes).

1. Press the button with the clock symbol.

A '0' will appear on the display, indicating the program for current day and hour information.

2. Use the up-down arrow under the display to select the value for the desired day of the week, from Monday (1) to Sunday (7).

3. Press the button with the clock symbol once again.

Two times will appear, one in each display. The display on the left shows the start time, while the display on the right shows the finish time.

4. The blinking dot next to the start time indicates that this is the value that may be modified. Use the up-down arrow under the display to select the desired value.

5. Press the button with the clock symbol once again.

The dot changes to the finish time.

6. Use the up-down arrow under the display to select the desired value.

7. Press the button with the clock symbol once again.

The selected program will appear once again. Use the up-down arrow under the display to select other programs.

8. Pressing either the up or the down arrow for element selection will exit this program and return to the tank temperature display.

The green LED next to the 'ON/OFF' button will remain blinking as long as there is an equipment disconnection time programmed for the current day.

**Disabling the equipment activation/deactivation program**

It is possible to disable the equipment activation/deactivation programming without canceling the daily programming. This way the programmed data is saved, but the programming will have no effect on the equipment.





1. Press the button with the clock symbol.

A '0' will appear on the display, indicating the program for current day and hour information.

2. Use the up-down arrow under the display to go past the selection for the last day of the week (7).

The message 'ON/OFF' will appear on the display, depending on the current status.

3. Press the button with the clock symbol once again.

The status will alternate each time you press the button.

4. Pressing either the up or the down arrow for element selection will exit this program and return to the tank temperature display.

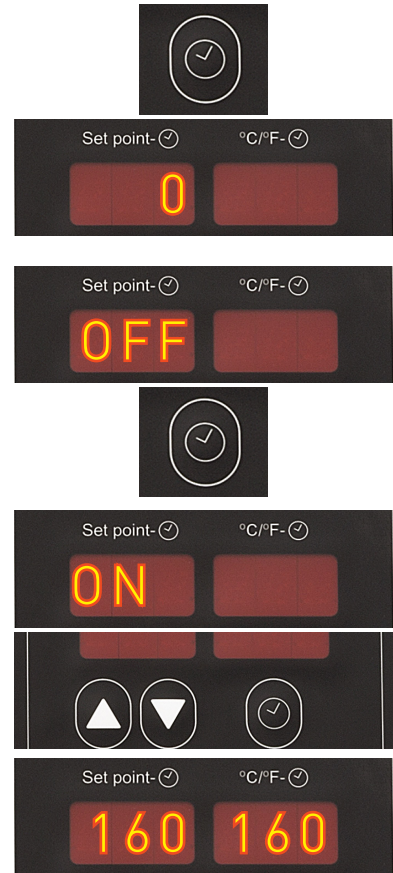

**Programming the equipment’s standby function activation/deactivation**

You may program an activation and a deactivation time for every day of the week, from Monday (1) to Sunday (7).

Time is expressed in 15 minute increments, so we cycle from 10.0 (10 hours and 0 minutes) to 10.1 (10 hours and 15 minutes) to 10.2 (10 hours and 30 minutes) to 10.3 (10 hours and 45 minutes).

1. Press the button with the clock symbol.

A '0' will appear on the display, indicating the program for current day and hour information.

2. Press the standby function button.

A '1' will appear, indicating the first day in the standby function programming.

[Since the current time and date are values common to both programs, the value '0' does not appear in this menu].

3. Use the up-down arrow under the display to select the desired value for the day of the week, Monday (1) to Sunday (7).

4. Press the button with the clock symbol once again.

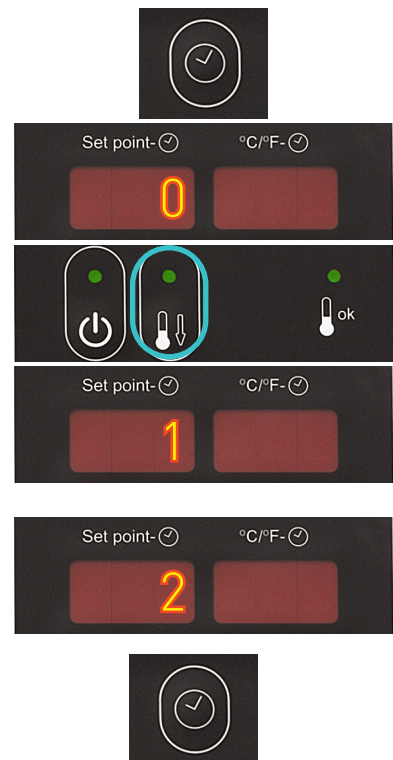



Two times will appear, one in each display. The left display shows the start time, while the right display shows the finish time.

5. The blinking dot next to the start time indicates that this is the time that may be modified.

Use the up-down arrow under the display to select the desired value.

6. Press the button with the clock symbol once again.

The dot changes to the finish time.

7. Use the up-down arrow under the display to select the desired value.

8. Press the button with the clock symbol once again.

The selected program appears once again. You may use the up-down arrow under the display to select other programs.

9. Pressing either the up or the down arrow for element selection will exit this program and return to the tank temperature display.

The green LED next to the 'standby' button will remain blinking as long as there is an equipment standby function activation time programmed for the current day.

### Disabling the equipment standby function programming

It is possible to disable the equipment standby function programming without canceling the daily programming. This way the programmed data is saved, but the programming will have no effect on the equipment.

1. Press the button with the clock symbol.

A '0' will appear on the display, indicating the program for current day and hour information.

2. Press the standby function button.

A '1' will appear, indicating the first day in the standby function programming.

3. Use the up-down arrow under the display to go past the selection for the last day of the week [7].

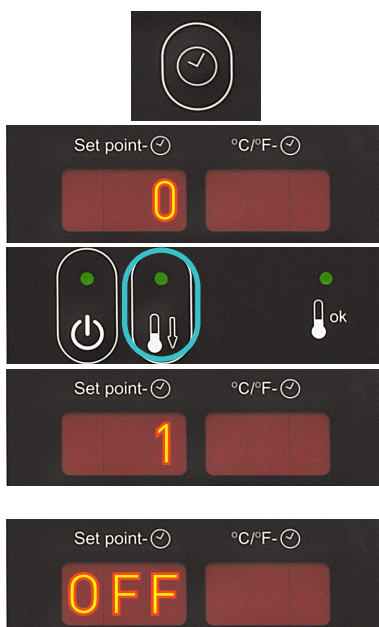

The message 'ON/OFF' will appear on the display, depending on the current status.

- Press the button with the clock symbol once again.

The status will alternate each time you press the button.

- Pressing either the up or the down arrow for element selection will exit this program and return to the tank temperature display

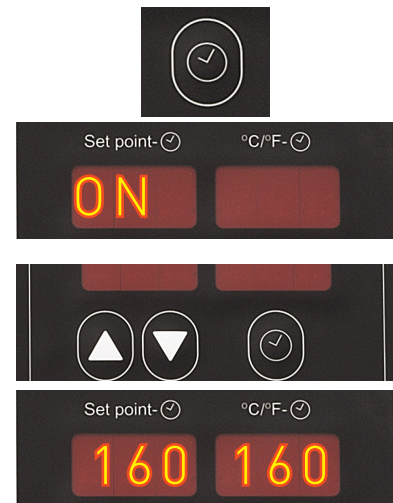

## Special function buttons

The simplicity of programming 'B4' series melters/applicators reduces the use of the special function buttons to only the standby function.

This manual function allows you to alternate between the operational mode and the standby mode. Using the standby function during periods of melter/applicator inactivity helps save energy and allows the heated elements to return quickly to their set point temperatures once you return to the operational mode.

When the standby function is activated, the set point temperature for all the heated components is lowered to a certain value, according to the programmed parameter (see 'Programming melter/applicator equipment parameters'). For example, if the tank set point temperature is 160 °C and the standby temperature is programmed as 30 (30%), when you press the standby function button, the tank set point temperature will drop to 112 °C (70% of 160 °C).

The three means for activating the standby function available with 'B4' melters/applicators have the following priority protocols:

- Manual standby function button.
- Standby function external signal.
- Standby function activation/deactivation programming.

Therefore, if the function is activated by any of the three means, it may always be deactivated using the manual button. On the other hand, if it was activated using the manual button, it may not be deactivated by either of the other two means. The weekly programming may not deactivate a standby function that has been activated by either of other two means.

The following criteria are suggested for standby function use:

- If the period of inactivity is less than 2 hours, allow the melter applicator equipment to heat as normal.
- If the period of inactivity is more than 2 hours and less than 4 hours, use the standby function.

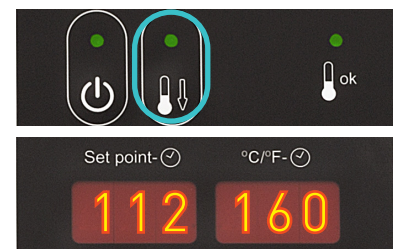

- If the period of inactivity is over 4 hours, use one of the following two options: turn off the equipment if you do not plan on using it for the rest of the day or keep the standby function on if you plan on using the equipment during that same day.

## Pump start/stop control

In piston pump version pneumatic driver is activated directly from the control card when the starting signal goes ON, if the compressed air supply has been connected and the pressure regulator is not set to '0' (see pressure gauge).

In gear pump version electric driver (motor) is activated by means of starting switch in the front of the unit, if the control card has activated the starting signal.

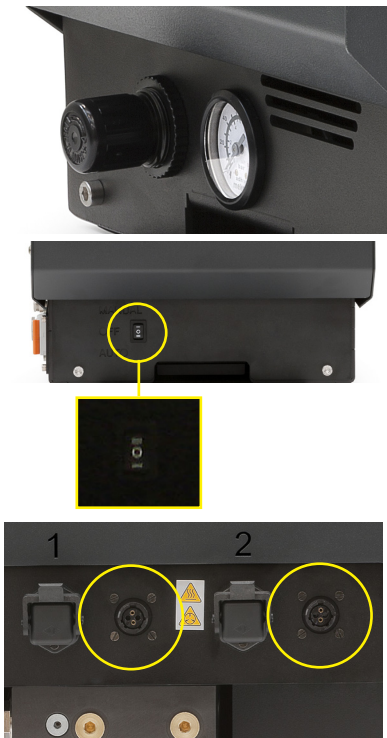

You can start the motor by means of an external signal, a hand gun trigger switch for example, connecting this contact to the rear rounded connector placed beside the hose-gun connector.

Thus the motor will be activated while the external contact is ON.

## By-pass valve regulation

The pumping system using a geared pump provides a constant flow of adhesive, according to the pump's rotational speed.

In this type of system, the pressure generated by the pump is the result of the retentions found on the circuit (the length and diameter of the hose, elbows in the connectors, the diameters of the nozzle outputs, etc.) and the adhesive itself (its viscosity).

For safety reasons, this pressure must be discharged when the circuit exceeds the operating value (normally with a closed circuit and the pump activated), which makes the use of a discharge valve or a by-pass valve necessary.

To adjust the pressure with this valve model (in an approximate manner), follow these steps:

1. Screw the spindle in clockwise, as far as possible. In this position, the maximum pressure is 80 kg/cm<sup>2</sup>.
2. Gradually loosen by turning counterclockwise until reaching the desired pressure. Each millimeter that the spindle sticks out represents a reduction of approximately 9 kg/cm<sup>2</sup>.

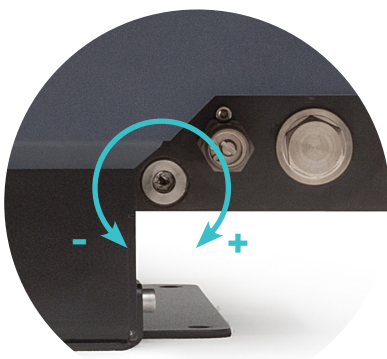

## Turning off the melting equipment

If it is necessary to disconnect the melting equipment:

1. Switch the motor switch, if gear pump is present, on the unit to the '0' position.
2. Disconnect the melter power switch located at the left side, next to the power intake.
3. Disconnect the pneumatic power supply from the guns and the electrical power supply from the control programmer, if there is one.

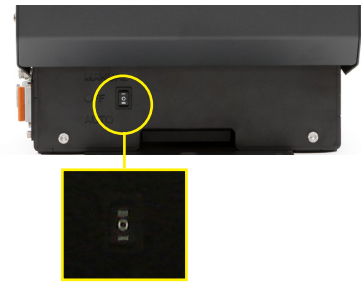

This page is intentionally left blank.

## 5. MAINTENANCE

**Warning:** The melter/applicator equipment is equipped with current technology, but has certain foreseeable risks. Therefore, only allow qualified personnel with enough training and experience to operate install or repair this equipment.



The following table briefly summarizes the indications for adequate melter/applicator equipment maintenance. Always read the corresponding section carefully.

Operation	Frecuency	Refer to
External cleaning	Daily	Equipment cleaning
Despresurización del sistema	Before performing maintenance tasks and repairing the hydraulic system	Depressurizing the system
Emptying and cleaning the tank	- When burnt adhesive is present - With each adhesive change	Tank cleaning
Filter cleaning or changing	- As needed (once a year minimum) - With each adhesive change	Filter maintenance
Check for pump leaks	Depending on the hours of operation and the temperature and speed parameters(min. once per month)	Pump maintenance
Check the lubrication (motor and gear)	Depending on the temperature and conditions of use (max. 8000 hours)	Motor gear maintenance
Equipment change	- Equipment change or repair	Dettaching equipment from base

If the equipment does not work or works incorrectly, called to your 'melter' Representative or to the Main Office.

### External cleaning

To continue to take advantage of the melter/applicator's benefits and to ensure the perfect mobility of its components, it is necessary to keep all its parts clean, especially the ventilation grates on the of the machine.

**Warning:** Risk of electric shock. Carelessness may result in injury or death. Clean the exterior using a cloth moistened with water. Do not use flammable liquids or solvents.



External cleaning:

- Use cleaning products compatible with painted surfaces.
- Apply the cleaning product with a soft cloth.
- Do not use sharp tools or scrapers with sharp edges.



#### Removing tank cover:

1. Disconnect the melter/appliator equipment.
2. Disconnect the compressed air from the equipment intake (piston version).
3. Remove the four screws fastening the tank cover.
4. Remove the cover sliding it in the direction shown in the figures.
5. To replace the panels, follow steps 1 through 4 in the reverse order.

#### Removing control box cover:



1. Disconnect the melter/appliator equipment.
2. Disconnect the compressed air from the equipment intake (piston version).
3. Remove the four screws fastening the control box cover.
4. Remove the cover sliding it in the direction shown in the figures.
5. To replace the panels, follow steps 1 through 4 in the reverse order. el equipo fusor.



#### Opening the control box to get into the base frame for controlling inner devices:

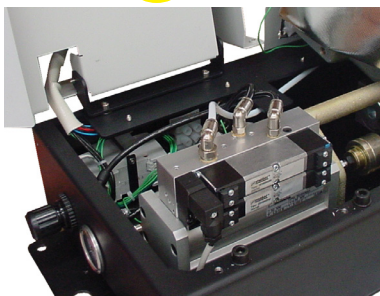

1. Follow the last steps from 1 to 4 to remove the tank and control box covers.
2. Remove two screws which fix the control box to the base frame.
3. Swing control box to the left side.
4. Follow steps 1 through 3 to close the control box.



## System depressurization

'B4' adhesive melter works as a pressurized system so precautions related to this type of equipment must be observed, even in gear pump units where a by-pass valve limits the maximum pressure within the system, especially during continuous pumping periods with closed applicator guns.

However, even with the motor turned off, residual pressure may exist in the circuit. This must be kept in mind when performing any operation on the hydraulic circuit.

Before disconnecting any hydraulic element or opening any distributor outlet, it is necessary to perform the following steps:

1. Disconnect the equipment power switch located on the side, next to the power intake.
2. Operate the purge valve housed in the distributor to free any residual pressure from the circuit (for open turn anti-clockwise sense).
3. Manually purge (or use the corresponding control command) all the guns that have been used.

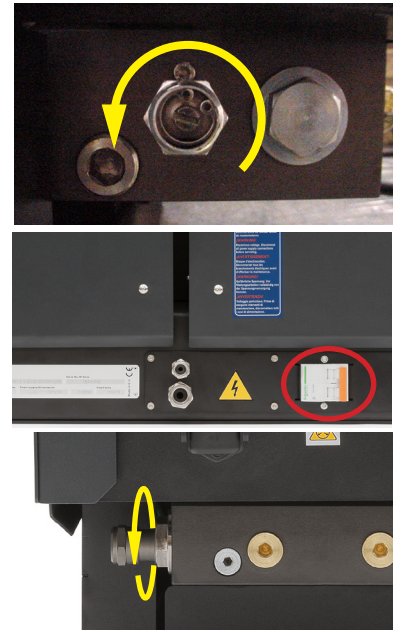

## Cleaning the tank

The hot-melt tank must be cleaned on occasion to maintain its fusion and anti-adherence properties. The tank is covered on the inside with PTFE and inclined enough to aid unloading the hot-melt and to avoid it from being retained inside when consequential burning occurs.

Furthermore, when adhesives are mixed, reactions may occur between them, causing a degeneration and thus problems in unloading in the direction of the pump.

Therefore, it is recommended to clean the deposit every time that:

- A change is made to a different type of hot-melt.
- Too much burnt material is generated in its interior.

### Changing adhesive type.

1. Use up as much of the adhesive as possible.

If it is necessary to unload the adhesive without having used it up as much as possible, follow the instructions in the section 'Emptying the tank'.

2. Clean the remains of hot-melt adhesive on the inside of the tank.

**Warning:** Use appropriate protective equipment for high temperatures.

3. Add the appropriate type and quantity of the new adhesive, wait for it to melt and pump at least one full tank through the system (hoses and guns).

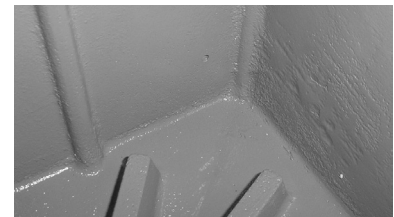

### Cleaning burnt adhesive

1. Empty the tank directly (see the section 'Emptying the tank') to prevent the burnt material from passing through the pump circuit.
2. Clean the adhesive remains and burnt material inside the tank. Do not use sharp objects that might damage the inside coating.



**Warning:** Use appropriate protective equipment for high temperatures.

3. Add the appropriate type and quantity of adhesive and wait for it to melt.
4. Remove the filter cartridge and clean it, if necessary (see the section 'Filter maintenance').
5. Reassemble the filter without the cartridge.
6. Pump a minimum of one tank through the distributor output.
7. Remove the filter and attach it to the corresponding cartridge. Reinstall it in the distributor.
8. Refill the tank with adhesive, wait for it to melt and continue working as usual.



**Warning:** Whenever you handle the filter or any other element subject to pressure, you must always perform a system depressurization first (see the corresponding section)

### Emptying the tank

During normal maintenance activities, it is recommended, and sometimes necessary to empty the tank.

To do so, follow these instructions:

1. Maintain the tank at operating temperature.
2. Put a container below the purge valve to collect the adhesive.
3. Unscrew the purge valve, anti-clockwise sense to open, with a screwdriver.
4. Put the pump at its maximum speed.
5. After the tank has been emptied, close the purge valve, remove the container and clean the purge valve output for future operations.

**Warning:** Use appropriate protective equipment for high temperatures.



## Maintenance of the filters

'B4' melter/appliator equipment is equipped with a 100 mesh pump filter. The filter prevents impurities and burnt adhesive remains from being pushed out from the tank by the pump.

The adhesive flows from the inside to the outside of the filter, with impurities being trapped inside it.

In piston pump version, there is also a filter in the tank's inlet valve. This filter performs a first-step filtration, preventing impurities resulting from burning in the tank and other impurities that may enter from the outside from passing through.

The filters can be cleaned or replaced with new ones.

No rule exists for determining when to change the filters. Several factors influence this decision:

- the type and purity of the adhesives used.
- the adhesive work temperatures.
- adhesive consumption in relation to the time it spends in the tank.
- changes in the type of adhesive used.

In any case, we recommend that the filters are checked and cleaned at least every 1000 hours of operation (melter turned on).

**Warning:** Always use protective gloves and goggles. Risk of burns.



### Changing the pump filter

1. Depressurize the system.
2. Using a 22 mm wrench, unscrew the hexagonal filter cap and remove it.
3. Unscrew the filter nut (1) and remove the mesh (2) from the filter (3).
4. Depending on the dirt inside the mesh (2), clean it or dispose of it directly, abiding by any existing waste regulations.
5. Screw back the filter nut (1) back and place the filter inside the distributor.
6. Replace the filter cap seal if damaged.
7. Screw the filter cap once more and tighten as much as possible.
8. Continue with normal operation.

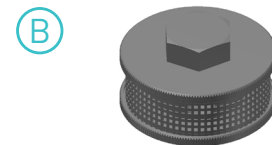
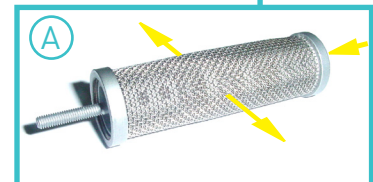
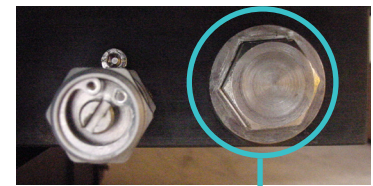

hexagonal filter CAP

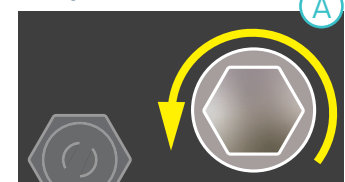

hexagonal filter CAP

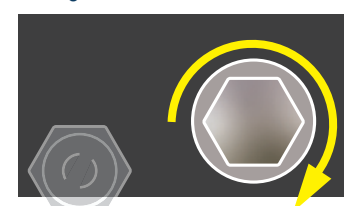

### Changing the inlet filter



**Warning:** It is important to install and remove the filter as instructed below, to prevent the inlet valve from coming loose.

Bear in mind that the inlet filter is screwed onto the inlet valve via a right-handed thread and that this, in turn, is screwed onto the distributor's adapter via a left-handed thread.

1. Empty the tank.
2. Remove the grid from the bottom of the tank, taking care not to scratch it.
3. Put the unit on Standby.
4. Remove the filter unit with a size 17 socket driver, turning the unit's head anticlockwise.
5. Depending on how dirty the filter is, replace the mesh or the entire unit, disposing of it in accordance with the current waste regulations.
6. Reinstall the filter unit, screwing it clockwise onto the inlet valve.



**Important:** It should only be tightened by hand and should not be forced, to avoid loosening the inlet valve.

7. Fill the tank with adhesive and continue working as normal.

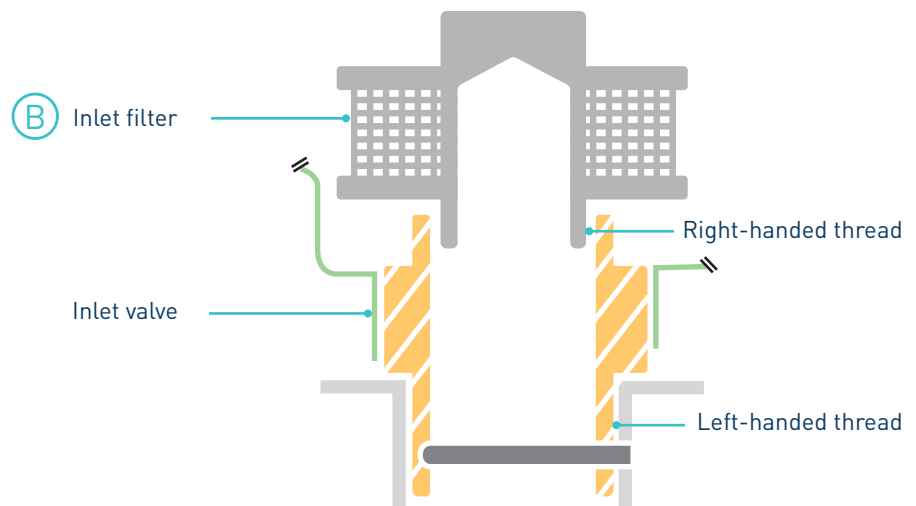

## Pump maintenance (gear version)

### Inspecting for leaks

The pump is equipped with a gasket system in the shaft and gaskets in the seating pump to prevent adhesive leaks through it. Some adhesive can sometimes leak out and therefore the gasket system in the shaft or the gaskets in the seating pump must be changed. Before making any changes, make sure the position of the leak.

**Warning:** Change the gasket when the pump is hot.

Remove the shaft coupling from the pump. Remove the screws fastening the gasket. Replace the gasket system in the shaft or the gaskets in the seating pump and reassemble.

However, before making any changes and in case of doubt should check with the Technical Assistance Service of 'meler'.

**Warning:** Always wear protective gloves and safety glasses. Risk of burns.

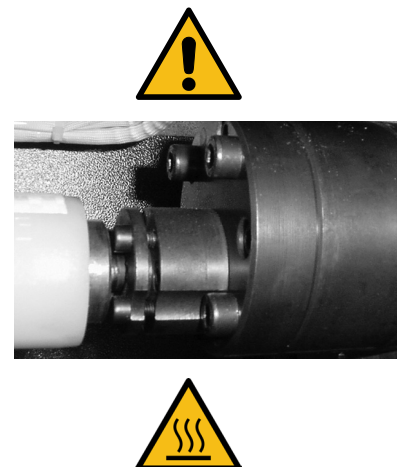

## Motor-gear maintenance (gear version)

### Cleaning the motor fan

Periodically inspect the condition of the motor fan and its vent screen.

If dust has accumulated, blow gently with air to clean it (remove the protective cover, if necessary).

### Checking the lubricant

The gear reducers are delivered filled with synthetic grease for lubrication -free of outside contamination- 'for life'. Ambient temperature  $0 \div 40$  °C, with peaks of as low as  $-20$  °C and up to  $+50$  °C. Use only those lubricants recommended by the manufacturer. The use of other types may cause premature wear or damage to the gear reducer.

Approximately 0.1 kg of lubricating grease fits in the gear reducer model used.

### Recommended lubricant:

Grasa Kluber, Staburags NBU 12/300.

**Warning:** Always use protective gloves and glasses. Risk of burns.

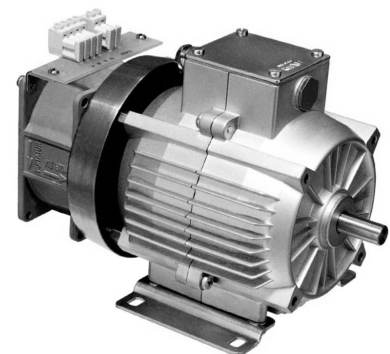

## Detaching the equipment from its base

For more thorough equipment maintenance, it is necessary to remove it from its present location to be able to perform operations more comfortably and with greater accessibility.

To do this, the equipment should be removed from its base in the following manner:

1. Disconnect the equipment electrically from the main power switch.
2. Depressurize the system.
3. Disconnect the hoses connected to the distributor outputs both electrically and hydraulically.
4. Disconnect the power input and the ground connection.
5. Unscrew the screw fastening the equipment to the base.
6. Raise the equipment off its base.

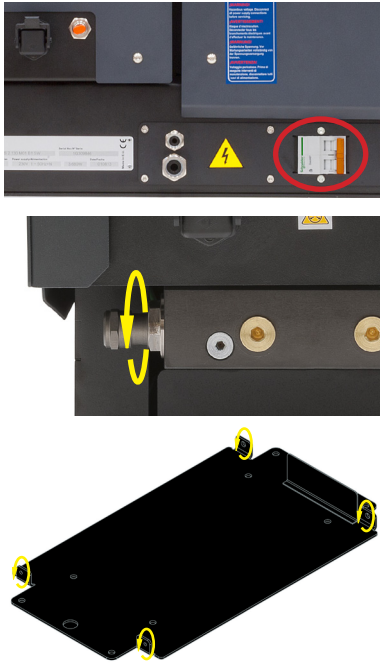

## 6. TECHNICAL CHARACTERISTICS

### General

	<b>Piston pump</b>	<b>Gear pump</b>
Tank capacity	4 liters	4 liters
Pumping rate <b>(*)</b>	29.3 kg/h 7cc pump	6 kg/h 2 cc/rev pump (50 rpm)
Melting rate <b>(*)</b>	6.0 kg/h	6.0 kg/h
Electrical outputs	2	2
Hydraulical outputs	2	2
Temperature range	40 to 200°C (100 to 392°F)	40 to 200°C (100 to 392°F)
Temperature control	RTD ±0.5°C (±1°F) Pt100 or Ni120	RTD ±0.5°C (±1°F) Pt100 or Ni120
Max. working pressure	81,6 bar (1183 psi)	40 bar (580 psi)
Pump speed	-	50 rpm fixed
Max. power installed (at 230V)	3680 W	3680 W
External functions	Temperatures ok output Standby input	Temperatures ok output Standby input Motor start-stop
Electrical requirements	LN ~ 230V 50Hz + PE	LN ~ 230V 50Hz + PE
Workplace temperature	0 to 40°C	0 to 40°C
Dimensions	see drawing on the next page	see drawing on the next page
Weight	36 kg (empty)	38 kg (empty)

**(\*)** Under standard conditions

## Dimensions

### Melting unit

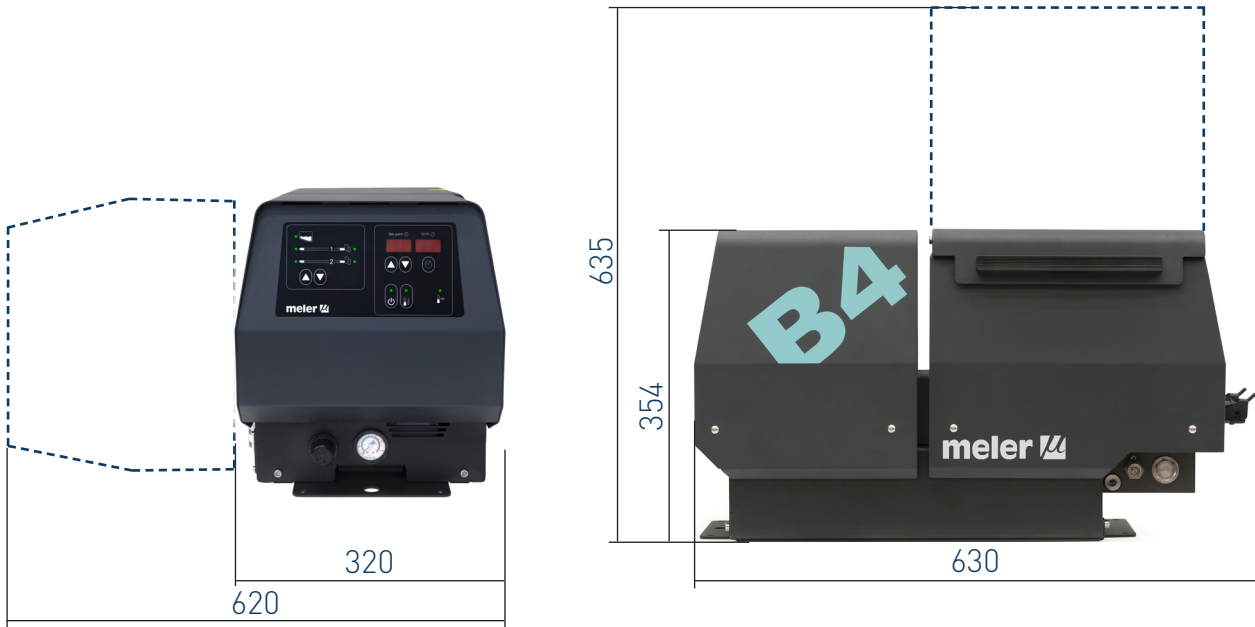

### Base plate

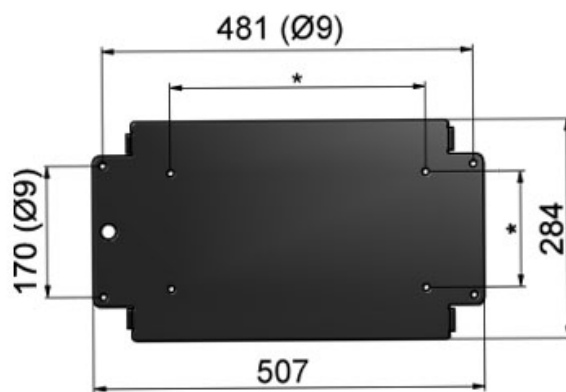

\* For ML-240-ST series replacement



## 7. ELECTRICAL DRAWINGS

This page is intentionally left blank.

## 8. PNEUMATIC DRAWINGS

### Components list (\*)

- 1 Inlet filter (filtering disk)
- 2 Solenoid valve 3/2 manual override (230V 50 Hz 1.5VA)
- 3 Pressure regulator 1-8 bar
- 4 Pressure gauge 0-10 bar
- 5 Pneumatic valve 5/2
- 6 Differential valve
- 7 Pneumatic cylinder double acting double chamber  
Ø50x50 (7cc pump)
- 8 Exhaust port filter

\* ONLY FOR PISTON PUMP VERSIONS

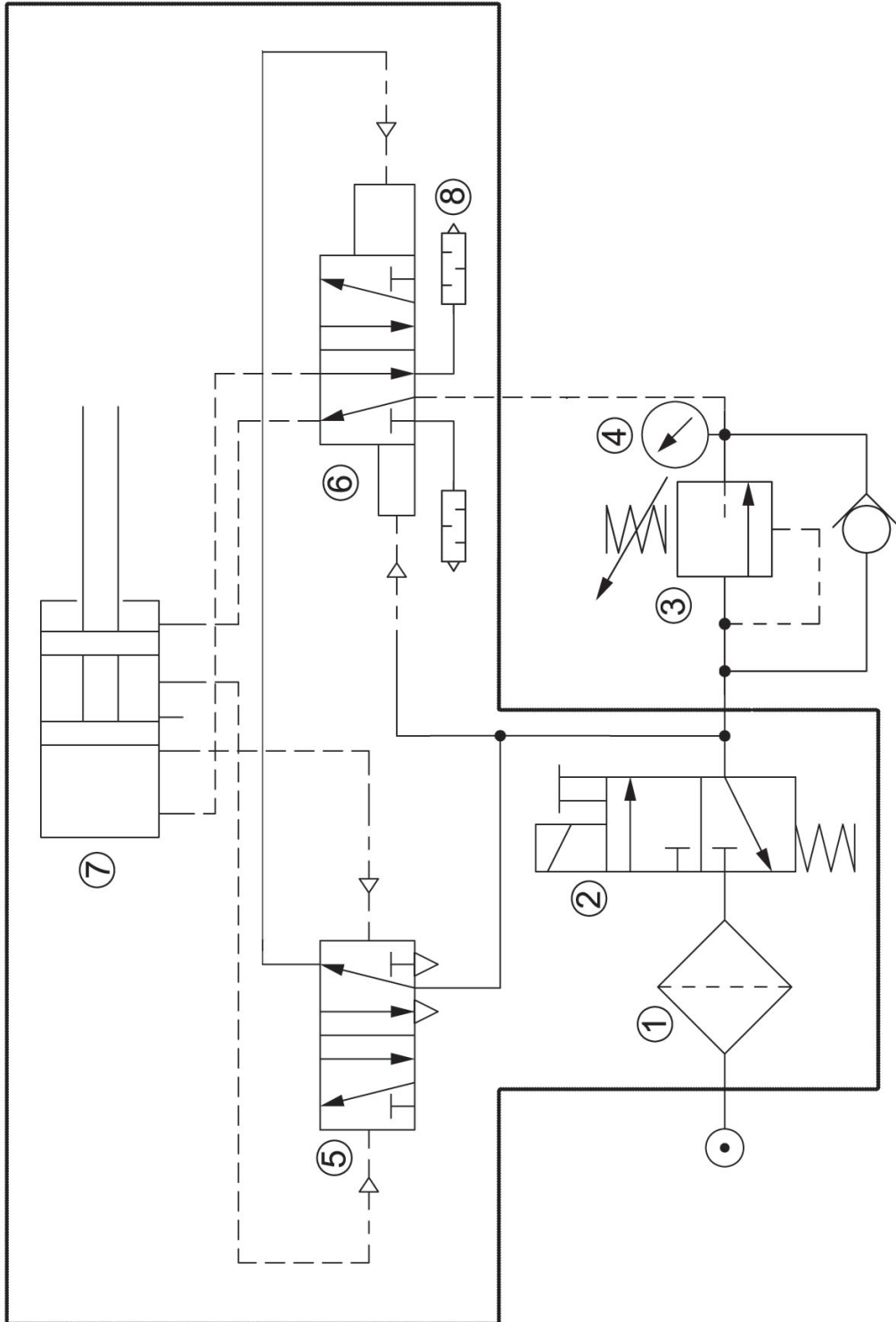

## 9. SPARE PART LIST

The most common spare parts list of the 'B4' adhesive melters is shown in this chapter to give you a quick and sure guideline to choose them.

The spare parts are listed by groups in a natural order as they are located on the units.

As a visual help the manual includes drawings of the components with a drawing number to easy find them through the list.

The list gives you the part number and description, showing if it is necessary, if the part number belongs to a piston or gear pump version.



This page is intentionally left blank.

**A. TANK GROUP**

Nº	Ref.	Description
1	150112100	Complete tank assembly piston pump
1	150112110	Complete tank assembly gear pump
1.1	150028940	PTFE coated tank piston pump
1.1	150026180	PTFE coated tank gear pump
2	150028970	Insulation mantle
3	150024650	Junta boca depósito
4	150112090	Tank gasket
5	10030009	Safety thermostat 240°C
6	150022640	Tank RTD sensor Pt-100 micron
6	150022650	Tank RTD sensor Ni-120 micron
7	10030007	Tank hook-up fitting-electrical lead
8	150115280	Tank grid
9	10100070	Flat tank filter piston pump
9.1	10100071	Flat tank filter mesh 100

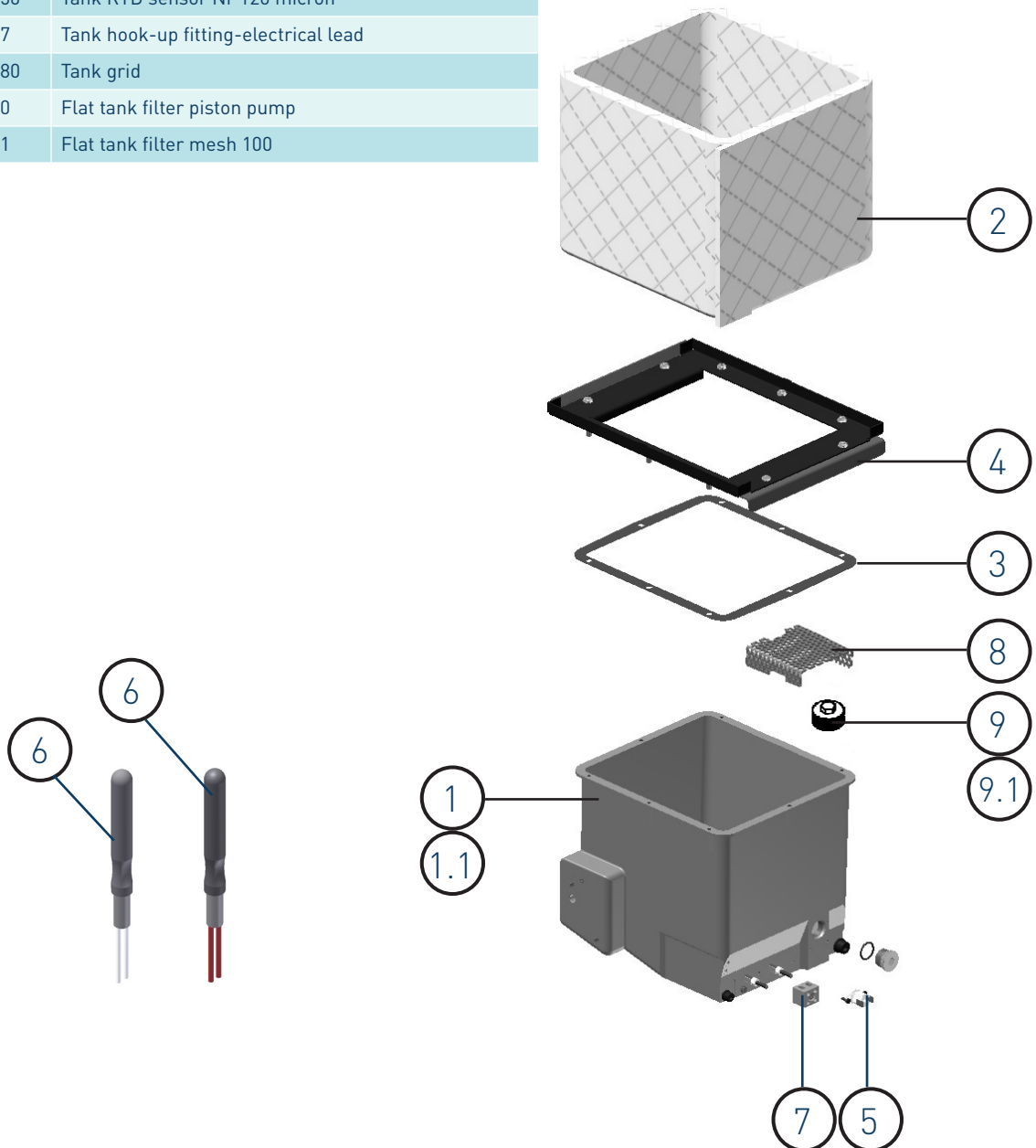

**B. PUMP GROUP**

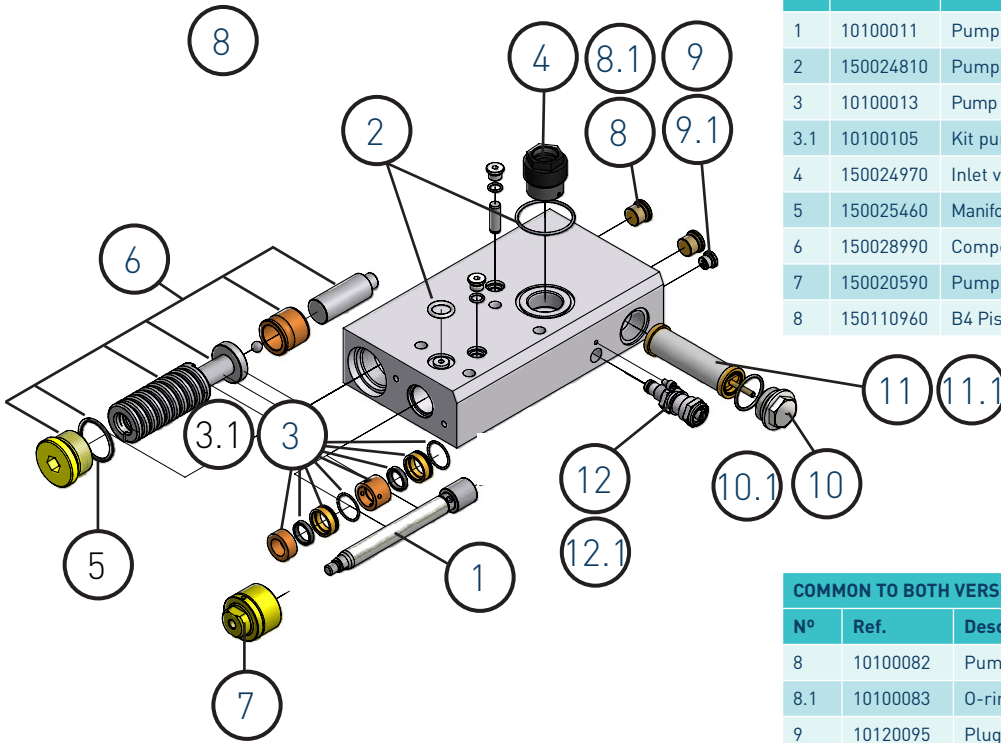

PISTON PUMP VERSION		
N°	Ref.	Description
1	10100011	Pump shaft
2	150024810	Pump seating o-rings
3	10100013	Pump shaft guide tips and fittings assembly
3.1	10100105	Kit pump shaft retainer fittings
4	150024970	Inlet valve fitting
5	150025460	Manifold cap o-ring (compensation valve)
6	150028990	Compensation valve assembly
7	150020590	Pump shaft short hinge joint
8	150110960	B4 Piston Complete Distributor (*)

COMMON TO BOTH VERSIONS		
N°	Ref.	Description
8	10100082	Pump plug with o-ring
8.1	10100083	O-ring pump plug
9	10120095	Plug with o-ring compensation valve
9.1	10120096	O-ring compensation valve plug
10	150029000	Filter plug with o-ring
10.1	10100053	Filter plug o-ring
11	10100090	Pump filter assembly
11.1	10100051	Pump filter mesh 100
12	150026330	Complete purge valve
12.1	150026340	Purge valve o-ring

GEAR PUMP VERSION		
N°	Ref.	Description
1	150114820	Pressure relief valve assembly
1.1	150090370	Pressure relief valve o-ring
1.2	150090380	Pressure relief valve blue spring
1.3	150026060	Pressure relief valve closing needle
1.4	150090390	Pressure relief valve seeger ring
2	150090360	Tank-distributor seating o-ring
3	150026110	2cc/rev gear pump
3.1	150090410	Pump seating o-rings
3.2	150096570	Seal Ø10+O-ring gear pump set
4	150129250	Gearmotor Wanshin 1-AC AV-B4 (*)
4	150129220	Kelvin gearmotor replacement kit (*)
4.1	150029020	Kelvin Motor capacitor
5	150026090	Motor coupling
6	150118650	Gear pump + B4 distributor (*)

(\*) Indicate Reference and serial number of the equipment

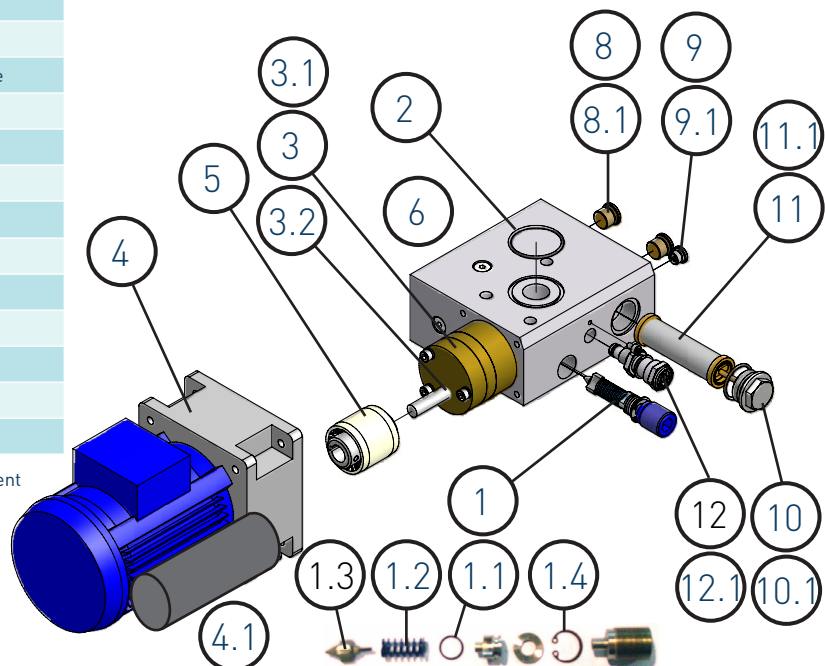



**C. PNEUMATIC GROUP (for piston pump version)**

N°	Ref.	Description
1	150025110	Pneumatic unit assembly 50x50 with filter
1.1	150020490	Differential valve with gasket
1.2	150020500	Slide pilot valve with gasket
1.3	150020520	Intake solenoid valve (220V AC)
1.4	150020540	Pneumatic unit fittings kit
1.5	10110051	Pneumatic unit 50x50 exhaust silencer
1.6	150020560	Pneumatic unit filtering disc (2)
1.7	150020580	Pneumatic unit 50x50 cylinder gasket kit
1.8	150020630	Connector 2P+T 15x15
1.9	150122850	Distributor-cylinder group seat gasket kit
2	10110031	Pressure regulator
3	10110030	Manometer
4	10120021	Quick air input fitting

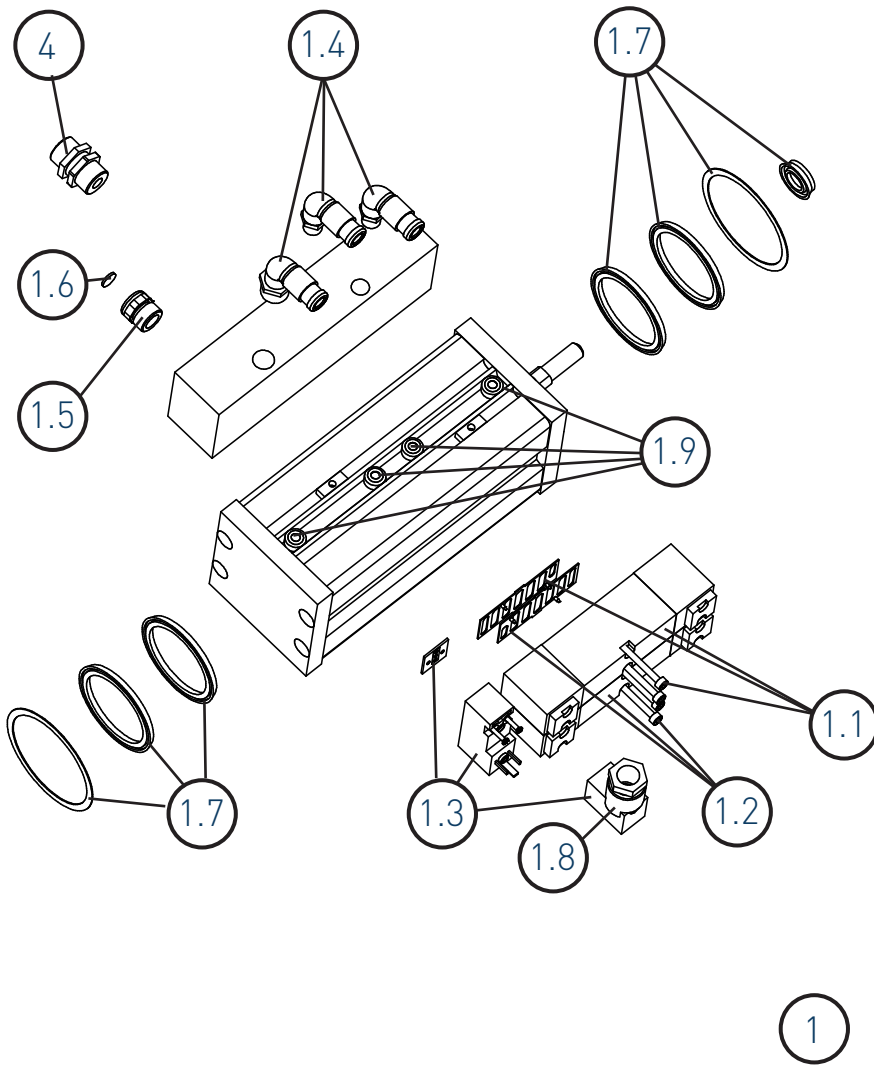
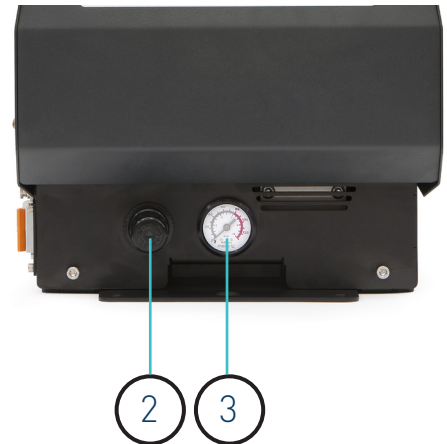

D. ELECTRICAL COMPONENTS

N°	Ref.	Description
1	150090480	Three-position switch
2	150021010	Circuit-breaker, 16A 2-pole
3	10000204	Control board
3.1	150112410	Fuse 6,3A 5x20 ultra fast
3.2	150115650	Fuse 10A 6x32 ultra fast
3.3	10010401	Fuse 1A 5x20
4	16010003	8 pin female connector (base housing)
5	150020720	12 pin female connector (base housing)
6	10140040	Cable gland Pg13.5
7	150021590	Cable gland Pg 9

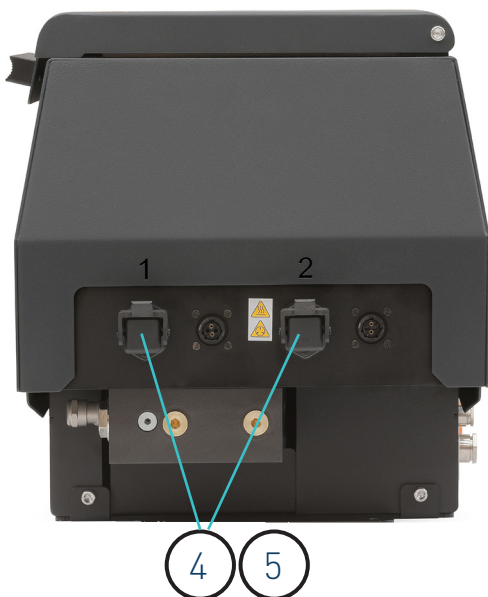
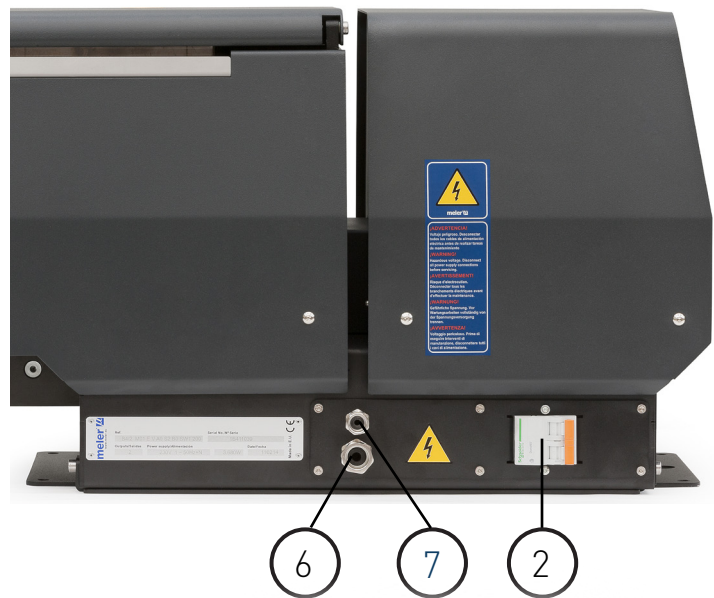
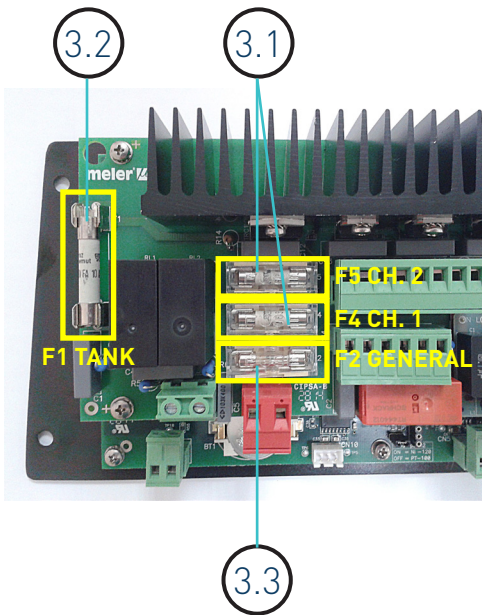

# EC DECLARATION OF CONFORMITY

*Original Declaration*

The manufacturer,

**Focke Meler Gluing Solutions, S. A.**  
P.I. Arazuri-Orkoien, c/B, nº3 A  
E - 31170 Arazuri - Navarra - Spain  
— Focke Group —

declaring that the machinery, Type:

Model:

Serial Number:

fulfils all the relevant provisions of the Directive 2006/42/EC on machinery,

and the object of the declaration described above is in conformity with the relevant Union harmonisation legislation:

- Directiva 2014/30/EU on the harmonisation of the laws of the Member States relating to electromagnetic compatibility .
- Directiva 2011/65/EU and its amendments on the restriction of the use of certain hazardous substances in electrical and electronic equipment.

In reference to the harmonised standards:

- EN ISO 12100:2010. Safety of machinery - General principles for design - Risk assessment and risk reduction.
- EN ISO 13732-1:2008. Ergonomics of the thermal environment - Methods for the assessment of human responses to contact with surfaces - Part 1: Hot surfaces.
- EN ISO 13849-1:2015. Safety of machinery - Safety-related parts of control systems - Part 1: General principles for design.
- EN ISO 14120:2015. Safety of machinery - Guards - General requirements for the design and construction of fixed and movable guards.
- EN 60204-1:2018. Safety of machinery - Electrical equipment of machines - Part 1: General requirements.
- EN 61000-6-2:2005, +/AC:2005. Electromagnetic compatibility (EMC) - Part 6-2: Generic standards - Immunity for industrial environments.
- EN 61000-6-4:2007, +/A1:2011. Electromagnetic compatibility (EMC) - Part 6-4: Generic standards - Emission standard for industrial environments.
- EN 50581:2012. Technical documentation for the assessment of electrical and electronic products with respect to the restriction of hazardous substances.

This declaration of conformity is issued under the sole responsibility of the manufacturer.

The person authorised to compile the technical file is the manufacturer established at the above address in this declaration.

Signed in Arazuri, to date:



**Javier Aranguren**  
Managing Director

---

For more information speak with your Focke Meler representative:



**Focke Meler Gluing Solutions, S.A.**  
Pol. Arazuri-Orkoién, c/B, nº3 A  
E-31170 Arazuri - Navarra - Spain  
Phone: +34 948 351 110  
info@meler.eu - [www.meler.eu](http://www.meler.eu)

*Focke Group*